



EEMANN
TECH WWW.EEMANN.TECH



CATALOGUE 2024



CONTENTS

ABOUT US	4-5
<hr/>	
SPRINGS	
CZ	8-23
1911/2011	24-32
TANFOGLIO	33-35
GLOCK	36-40
SIG SAUER	43-45
BERETTA	46-49
AR-15	50-53
AR-9 PCC	53
MOLOT-VEPR 12GA	54
BENELLI	55
GRAND POWER	56-58
DILLON PRECISION	59-62
PHOENIX	64-65
WALTHER	66
MAGLULA	67
SPS	67
KMR	68-69
<hr/>	
PARTS	
1911/2011	72-91
CZ	93-135
GLOCK	137-148
KMR	149
TANFOGLIO	150-151
AR-15	153-157
AR-9 PCC	158
AK	158
PHOENIX	158
SIG SAUER	159
<hr/>	
SPARE SCREWS	
CZ	162-163
1911/2011	164-165
GLOCK	166
KMR	167
AR-15	168
RED DOT MOUNTS	169
<hr/>	
TARGETS & PATCHES	
STEEL TARGETS	172-174
IPSC MINI POPPER	175
CARDBOARD TARGETS	176-178
TARGET PATCHES	179-181
ISSF 25M TARGET	182
DRY FIRING KITS	183
<hr/>	
TOOLS & CLEANING	
TOOLS	186-191
CLEANING ACCESSORIES	192
<hr/>	
APPARELS & ACCESSORIES	
APPARELS	196-199

EEMANN TECH is a distinguished leader in the world of shooting sports and firearm accessories.

With a legacy rooted in precision engineering and a commitment to excellence, we have earned a renowned reputation within the industry.

Our company was founded by a team of seasoned experts, each possessing extensive experience and knowledge in the realm of IPSC (International Practical Shooting Confederation), USPSA (United States Practical Shooting Association), and shooting sports competitors. Their deep understanding of the sport, gained through active participation at the highest levels of international competitions and organizational roles in IPSC and USPSA matches, sets us apart as a trusted authority.

At EEMANN TECH, our primary focus is on manufacturing and delivering high-quality spare and tuning parts, as well as a comprehensive range of accessories designed specifically for shooting sports enthusiasts. We're proud of the quality and innovation that goes into every product, making sure they meet the high standards of the shooting sports community.

Our dedication to excellence extends beyond our products. We are committed to providing outstanding customer support, technical expertise, and a seamless shopping experience for our customers worldwide. With a commitment to quality, performance, and safety, EEMANN TECH continues to be the preferred choice for shooting sports enthusiasts and professionals alike.

Explore our catalog and experience the EEMANN TECH difference today, where precision meets passion in the world of shooting sports.

Our mission

As a global mission, we are driven by enthusiasm to deliver top-quality products and professional services to customers worldwide, setting high performance standards for ourselves.

We combine our passion, excellence, and commitment with advanced technology and expertise to ensure precision and top-notch quality everywhere we do.

Our goal

Our primary goal is to help competitors achieve their best results and support them in reaching international success on their path to excellence.

Cooperation

We operate on a B2B dealer contract basis with gun shops worldwide. We do not engage in retail sales; our focus is strictly on B2B transactions.

EEMANN TECH's dealership cooperation is non-exclusive. We offer equal opportunities to all interested dealers to excel in the market. Any gun shop can express their interest in becoming an EEMANN TECH dealer and offer a wide selection of EEMANN TECH products in their stores to meet the needs of their customers.

If you are interested in collaboration and wish to become an EEMANN TECH dealer, please complete the Contact form to send your inquiries or requests to us on our website.

As a dealer, you will gain access to our extensive EEMANN TECH product line, as well as products from other brands we distribute. You will be among the first to receive updates, and your company will be prominently featured as an official dealer on our website and other social media channels. We are always open for cooperation and ready to answer any questions you have!



We offer a wide selection of tuning and factory-power springs for the most popular pistol models used in IPSC and USPSA shooting sports

including 1911/2011, CZ, Glock, Tanfoglio, Sig Sauer, Beretta, Benelli, Grand Power, Phoenix, AR-15/AR-9 PCC, and many others.



SPRINGS







Competitors can personalize their shooting gear with EEMANN TECH parts to meet their specific needs according to the division rules. We have all the necessary components for your handguns to match factory settings or customize them extensively with EEMANN TECH tuning springs and parts.

Thanks to advanced technology, our springs have an extended service life.

Eemann Tech Competition Recoil Spring for CZ



THE EEMANN TECH COMPETITION RECOIL SPRING FOR CZ

Reference nr.	Spring weight	Color
ET-131177	7 lbs	
ET-131178	8 lbs	
ET-131179	9 lbs	
ET-131180	10 lbs	
ET-131181	11 lbs	
ET-131182	12 lbs	
ET-131183	13 lbs	

The Eemann Tech Competition Recoil Spring has been specially designed for:

- CZ 75 SP-01 Shadow
- CZ Shadow 2

The spring also fits all CZ 75 pistols with long Recoil Spring Guide Rods.



Precise your **power** with colors

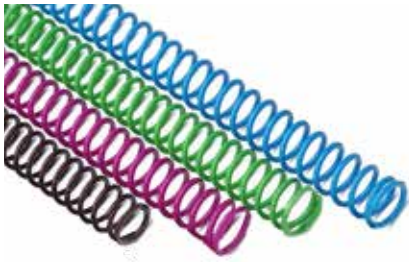

EEMANN TECH RECOIL SPRINGS CALIBRATION PACK FOR CZ

Reference nr.	Spring weight	Color
ET-131199		
↳ ET-131179	9 lbs - 1 pc.	■
↳ ET-131180	10 lbs - 1 pc.	■
↳ ET-131181	11 lbs - 1 pc.	■
↳ ET-131182	12 lbs - 1 pc.	■



EEMANN TECH RECOIL SPRING FOR CZ 75

Reference nr.	Spring weight
ET-131137	7 lbs
ET-131138	8 lbs
ET-131139	9 lbs
ET-131140	10 lbs
ET-131141	11 lbs
ET-131142	12 lbs
ET-131143	13 lbs
ET-131144	14 lbs
ET-131145	15 lbs
ET-131146	16 lbs
ET-131159	18 lbs
ET-131158	20 lbs



EEMANN TECH MAIN SPRING FOR CZ 75, CZ SHADOW 2

Reference nr.	Spring weight
ET-131117	7 lbs
ET-131118	8 lbs
ET-131119	9 lbs
ET-131120	10 lbs
ET-131121	11 lbs
ET-131122	12 lbs
ET-131123	13 lbs
ET-131126	16 lbs



EEMANN TECH EXTRACTOR SPRING FOR CZ 75, CZ SHADOW 2

Reference nr.	Caliber
ET-131152	9×19/9×21mm
ET-132152	.40S&W



EEMANN TECH FIRING PIN SPRING FOR CZ 75,
CZ SHADOW 2

Reference nr.

ET-131155



EEMANN TECH FIRING PIN SPRING LIGHT
(-15% POWER) FOR CZ 75, CZ SHADOW 2*

Reference nr.

ET-131156

*15% less from factory power



EEMANN TECH MAGAZINE CATCH RELEASE
SPRING FOR CZ 75, CZ SHADOW 2

Reference nr.

ET-131133



EEMANN TECH COMPETITION MAGAZINE CATCH
RELEASE SPRING (-10% POWER) FOR CZ 75, CZ
SHADOW 2

Reference nr.

ET-131200



EEMANN TECH SAFETY DETENT PLUNGER
SPRING FOR CZ 75, CZ SHADOW 2

Reference nr.

ET-131131



EEMANN TECH EJECTOR SPRINGS SET FOR
CZ 75 TACTICAL SPORT*

Reference nr.

ET-132174

*Two pieces set



EEMANN TECH MAGAZINE SPRING FOR
CZ CZECHMATE

Reference nr.

ET-131157



EEMANN TECH MAGAZINE SPRING
(OEM 18 ROUNDS) FOR CZ 75 SP-01 SHADOW

Reference nr.

ET-131147

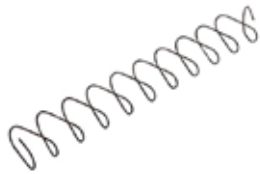

EEMANN TECH MAGAZINE SPRING
(MEC-GAR 19 ROUNDS) FOR CZ SHADOW 2

Reference nr.

ET-131148



EEMANN TECH MAGAZINE SPRING FOR
CZ 75 TACTICAL SPORTS, 9X19/.40SW

Reference nr.

ET-131149



EEMANN TECH MAGAZINE SPRING FOR
CZ 75, 16 ROUNDS MAGAZINE

Reference nr.

ET-131150



EEMANN TECH TRIGGER BAR SPRING FOR
CZ 75, CZ SHADOW 2*

Reference nr.

ET-131134



EEMANN TECH COMPETITION TRIGGER BAR
SPRING (-15% POWER) FOR CZ*

Reference nr.

ET-131201

*15% less from factory power



EEMANN TECH SLIDE STOP SPRING FOR
CZ 75, CZ SHADOW 2

Reference nr.

ET-131103



EEMANN TECH SEAR SPRING FOR CZ 75,
CZ SHADOW 2

Reference nr.

ET-131112



EEMANN TECH COMPETITION SEAR SPRING
(-10% POWER) FOR CZ 75, CZ SHADOW 2*

Reference nr.

ET-131113

*10% less from factory power



EEMANN TECH TRIGGER SPRING FOR
CZ 75, CZ SHADOW 2

Reference nr.

ET-131108



EEMANN TECH COMPETITION TRIGGER SPRING
(-15% POWER) FOR CZ 75, CZ SHADOW 2*

Reference nr.

ET-131109

*15% less from factory power



EEMANN TECH EXTREME TRIGGER SPRING
(+10% POWER) FOR CZ 75, CZ SHADOW 2*

Reference nr.

ET-131110

*10% more from factory power



EEMANN TECH COMPETITION TRIGGER SPRING
(-15% POWER) FOR CZ 75 TACTICAL SPORT*

Reference nr.

ET-132118

*15% less from factory power



EEMANN TECH EXTENDED COMPETITION SEAR
SPRING (-10% POWER) FOR CZ 75, CZ SHADOW 2*

Reference nr.

ET-131114

*10% less from factory power

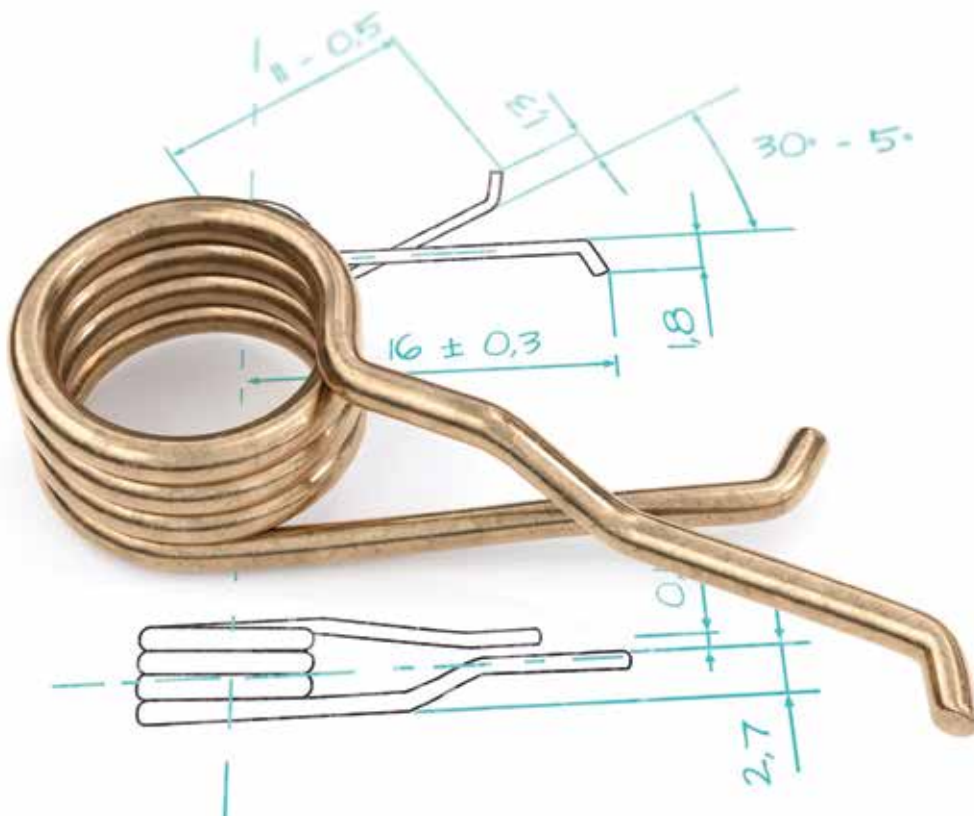

The **accuracy** on every level



EEMANN TECH COMPETITION SPRINGS KIT FOR CZ

Reference nr.

ET-131203

- ↳ ET-131141 - 1pc.
- ↳ ET-131119 - 1pc.
- ↳ ET-131109 - 1pc.
- ↳ ET-131156 - 1pc.
- ↳ ET-131113 - 1pc.

Compatible with:

- CZ 75, CZ 75B
- CZ 85, CZ 85B
- CZ 75 SP-01, CZ 75 SP-01 Tactical
- CZ 75 SP-01 Shadow, CZ 75 SP-01 Shadow Orange
- CZ Shadow 2, CZ Shadow 2 Orange

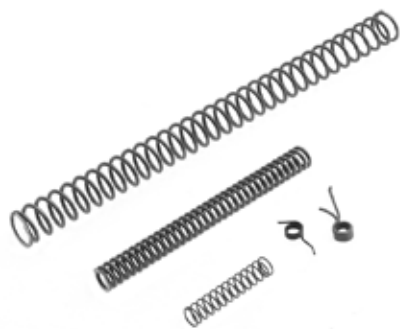

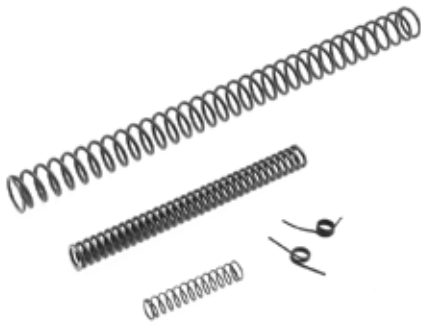

EEMANN TECH COMPETITION SPRINGS KIT FOR CZ 75 TACTICAL SPORT

Reference nr.

ET-131204

- ↳ ET-131141 - 1pc.
- ↳ ET-131119 - 1pc.
- ↳ ET-132118 - 1pc.
- ↳ ET-131156 - 1pc.
- ↳ ET-131113 - 1pc.

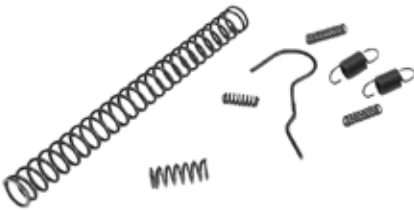

EEMANN TECH SPRINGS SET FOR CZ P-10

Reference nr.

ET-130112

NEW

- ↳ ET-130091 - 1pc.
- ↳ ET-130093 - 1pc.
- ↳ ET-190094 - 1pc.
- ↳ ET-130095 - 1pc.
- ↳ ET-130096 - 1pc.
- ↳ ET-130097 - 1pc.
- ↳ ET-130098 - 1pc.



EEMANN TECH COMPETITION SPRINGS KIT FOR CZ P-10

Reference nr.

ET-130117

NEW

- ↳ ET-130092 - 1pc.
- ↳ ET-130075 - 2pc.

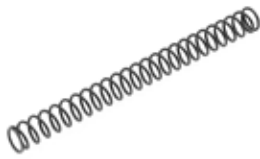
**EEMANN TECH FIRING PIN SPRING FOR CZ P-10****Reference nr.**

ET-130091

**EEMANN TECH DISASSEMBLY PLATE SPRING FOR CZ P-10****Reference nr.**

ET-130098

**EEMANN TECH TRIGGER BAR DISCONNECTOR SPRING FOR CZ P-10****Reference nr.**

ET-130097

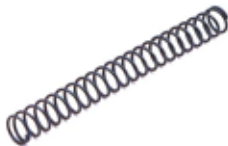
**EEMANN TECH COMPETITION FIRING PIN SPRING FOR CZ P-10****Reference nr.**

ET-130092

**EEMANN TECH MAGAZINE CATCH SPRING FOR CZ P-10****Reference nr.**

ET-130096



EEMANN TECH TRIGGER BAR SPRING FOR
CZ P-10 - 2PCS./SET

Reference nr.

ET-130095



EEMANN TECH COMPETITION TRIGGER BAR
SPRING FOR CZ P-10 - 2PCS./SET

Reference nr.

ET-130075

NEW



EEMANN TECH SLIDE STOP SPRING FOR CZ P-10

Reference nr.

ET-130094



EEMANN TECH SEAR SPRING FOR CZ P-07/P-09

Reference nr.

ET-130106



EEMANN TECH HAMMER DECOCKING LEVER
SPRING FOR CZ P-07/P-09

Reference nr.

ET-130099



EEMANN TECH SAFETY LATCH SPRING FOR
CZ P-07/P-09

Reference nr.

ET-130107



EEMANN TECH EXTRACTOR SPRING FOR
CZ P-07/P-09/P-10

Reference nr.

ET-130093

EEMANN TECH SPRINGS KIT FOR ADAPTER CZ SHADOW 2 KADET

Reference nr.

ET-132200

- ↳ ET-132201 - 1pc.
- ↳ ET-132202 - 1pc.
- ↳ ET-132203 - 1pc.
- ↳ ET-132204 - 1pc.
- ↳ ET-132205 - 1pc.
- ↳ ET-132208 - 1pc.



EEMANN TECH RECOIL SPRING FOR ADAPTER CZ SHADOW 2 KADET - WEAK (BLUE)

Reference nr.

ET-132205



EEMANN TECH RECOIL SPRING FOR ADAPTER CZ SHADOW 2 KADET - STRONG (RED)

Reference nr.

ET-132204



EEMANN TECH EXTRACTOR SPRING FOR ADAPTER CZ SHADOW 2 KADET

Reference nr.

ET-132202



EEMANN TECH FIRING PIN SPRING FOR ADAPTER CZ SHADOW 2 KADET

Reference nr.

ET-132203



EEMANN TECH MAGAZINE SPRING FOR ADAPTER CZ SHADOW 2 KADET

Reference nr.

ET-132208



EEMANN TECH RECOIL SPRING FOR ADAPTER CZ SHADOW 2 KADET

Reference nr.

ET-132201

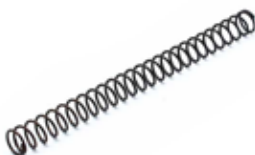



EEMANN TECH STRIKING MECHANISM SPRING
FOR CZ SCORPION EVO 3

Reference nr.

ET-133033



EEMANN TECH HAMMER SPRING FOR CZ
SCORPION EVO 3

Reference nr.

ET-133034



EEMANN TECH DISCONNECTOR SPRING FOR CZ
SCORPION EVO 3

Reference nr.

ET-133002



EEMANN TECH COMPETITION TRIGGER SPRING
FOR CZ SCORPION EVO 3

Reference nr.

ET-133003

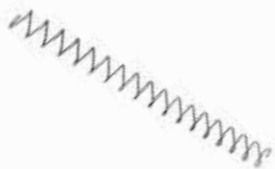

EEMANN TECH MAGAZINE SPRING FOR CZ
SCORPION EVO 3

Reference nr.

ET-133035



EEMANN TECH COMPETITION TRIGGER
SPRINGS KIT FOR CZ SCORPION EVO 3

Reference nr.

ET-133001



EEMANN TECH FIRING PIN SPRING FOR
CZ SCORPION EVO 3

Reference nr.

ET-133027



EEMANN TECH RECOIL SPRING FOR CZ SCORPION EVO 3

Reference nr.

ET-133031



EEMANN TECH EJECTOR SPRING FOR CZ SCORPION EVO 3

Reference nr.

ET-133088

NEW



EEMANN TECH SPRINGS KIT FOR CZ SCORPION EVO 3

Reference nr.

ET-133004

- ↳ ET-133002
- ↳ ET-133003
- ↳ ET-133027
- ↳ ET-133029
- ↳ ET-133033
- ↳ ET-133034





EEMANN TECH ULTIMATE SPRINGS KIT FOR CZ

Reference nr.

ET-131205

- ↳ ET-131141 - 1pc.
- ↳ ET-131119 - 1pc.
- ↳ ET-131109 - 1pc.
- ↳ ET-131156 - 1pc.
- ↳ ET-131113 - 1pc.
- ↳ ET-131200 - 1pc.
- ↳ ET-131201 - 1pc.
- ↳ ET-131152 - 1pc.

Compatible with:

- CZ 75, CZ 75B
- CZ 85, CZ 85B
- CZ 75 SP-01, CZ 75 SP-01 Tactical
- CZ 75 SP-01 Shadow, CZ 75 SP-01 Shadow Orange
- CZ Shadow 2, CZ Shadow 2 Orange



EEMANN TECH SPRINGS KIT FOR CZ 75

Reference nr.

ET-131160

- ↳ ET-131146 - 1pc.
- ↳ ET-131126 - 1pc.
- ↳ ET-131108 - 1pc.
- ↳ ET-131155 - 1pc.
- ↳ ET-131112 - 1pc.
- ↳ ET-131152 - 1pc.
- ↳ ET-131103 - 1pc.
- ↳ ET-131131 - 1pc.
- ↳ ET-131134 - 1pc.
- ↳ ET-131133 - 1pc.

Compatible with:

- CZ 75, CZ 75B
- CZ 85, CZ 85B
- CZ 75 SP-01, CZ 75 SP-01 Tactical
- CZ 75 SP-01 Shadow, CZ 75 SP-01 Shadow Orange
- CZ Shadow 2, CZ Shadow 2 Orange



EEMANN TECH EXTREME EXTRACTOR SPRING (+10% POWER) FOR CZ 75

Reference nr.

ET-131153

NEW



EEMANN TECH MAIN SPRINGS CALIBRATION PACK FOR CZ

Reference nr.	Spring weight	Color	
ET-131184			NEW
↳ ET-131187	7 lbs- 1 pc.	■	
↳ ET-131188	8 lbs- 1 pc.	■	
↳ ET-131189	9 lbs- 1 pc.	■	
↳ ET-131190	10 lbs- 1 pc.	■	
↳ ET-131193	13 lbs - 1 pc.	□	



EEMANN TECH COMPETITION MAIN SPRING FOR CZ

Reference nr.	Spring weight	
ET-131187	7 lbs	NEW
ET-131188	8 lbs	NEW
ET-131189	9 lbs	NEW
ET-131190	10 lbs	NEW
ET-131193	13 lbs	NEW



EEMANN TECH ULTIMATE UPGRADE KIT FOR CZ SHADOW 1/2

Reference nr.

ET-130126

NEW

- ↳ ET-131179 - 1pc.
- ↳ ET-131180 - 1pc.
- ↳ ET-131181 - 1pc.
- ↳ ET-131182 - 1pc.
- ↳ ET-131187 - 1pc.
- ↳ ET-131188 - 1pc.
- ↳ ET-131189 - 1pc.
- ↳ ET-131190 - 1pc.
- ↳ ET-131109 - 2pc.
- ↳ ET-131156 - 1pc.
- ↳ ET-131113 - 1pc.
- ↳ ET-130124 - 1pc.
- ↳ ET-130015 - 1pc.
- ↳ ET-303017 - 2pc.
- ↳ ET-130064 - 1pc.
- ↳ ET-130055 - 1pc.

Compatible with:

- CZ 75 SP-01 (without firing pin block models)
- CZ 75 Shadow Line
- CZ 75 SP-01 Shadow
- CZ 75 SP-01 Shadow Orange
- CZ Shadow 2
- CZ Shadow 2 Orange





Eemann Tech Progressive Recoil Spring for 1911/2011

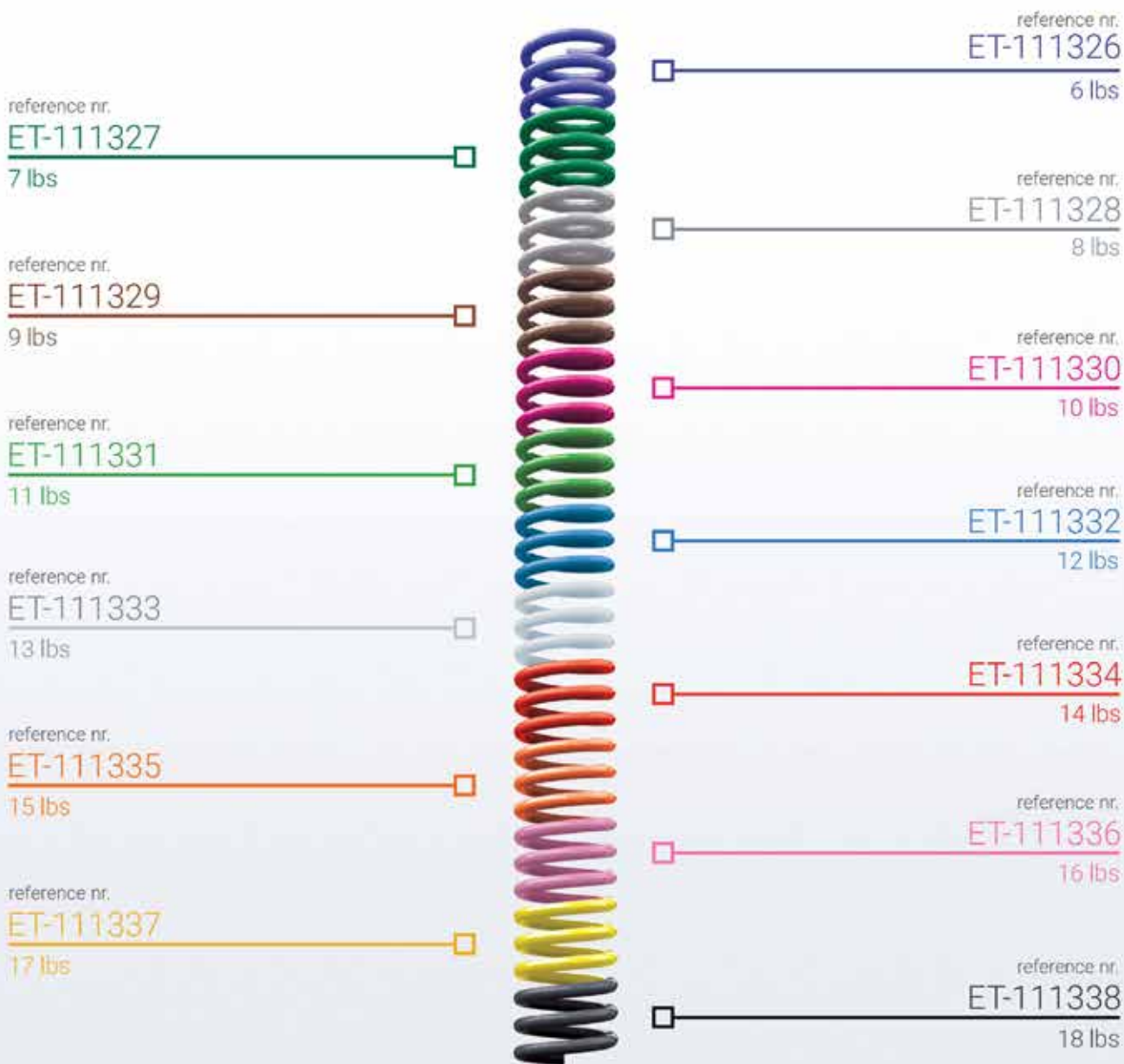

A wide selection for every preference



Eemann Tech Progressive Recoil Spring

The Eemann Tech Progressive Recoil Spring for 1911/2011 differs from the factory recoil spring in distance between coils. The progressive recoil spring coils are constantly reducing from the center to the end of the spring. The first part of the spring has standard factory coil gaps and is the strongest part.

The part with the “factory” coil gap starts compressing first and after the first coils impact the second part with “progressive” coil distance, they join together for faster recoil reducing to zero. At the end of the compression cycle, the progressive recoil spring’s power is ~10% greater than the declared value. As a result, if you use a weaker spring, the springs capacity remains the same.

Every spring’s power value is indicated by a unique color, that allows identifying the spring’s original power at any moment of its life. The Eemann Tech Progressive Recoil Springs are painted by a special polymer paint with thermal treatment, which remains elastic throughout the life of the spring. There are

special calibration packs for different types of handguns / IPSC divisions. Every calibration pack contains 4 springs of different power, for more precise calibration of the handgun for individual types of ammunition.

For maximum efficiency, it is recommended to use the Eemann Tech Progressive Recoil Spring with Eemann Tech Recoil Buffer (Reference code: ET-303011).

The Eemann Tech Progressive Recoil Spring has power selection from 6-18 lbs. This variety of spring power values allows them to be used with any type of handguns from OPEN division (6-7 lbs) to the Classic Major .45 caliber and factory ammunition with a light bullet (18 lbs).

When installing the Eemann Tech Progressive Recoil Spring, the strengthened part of the spring should be directed towards the chamber.



Eemann Tech Progressive Recoil Spring for 1911/2011



EEMANN TECH PROGRESSIVE RECOIL SPRING FOR 1911/2011

Reference nr.	Spring weight	Color
ET-111326	6 lbs	Blue
ET-111327	7 lbs	Green
ET-111328	8 lbs	Grey
ET-111329	9 lbs	Brown
ET-111330	10 lbs	Pink
ET-111331	11 lbs	Light Green
ET-111332	12 lbs	Cyan
ET-111333	13 lbs	White
ET-111334	14 lbs	Red
ET-111335	15 lbs	Orange
ET-111336	16 lbs	Purple
ET-111337	17 lbs	Yellow
ET-111338	18 lbs	Black

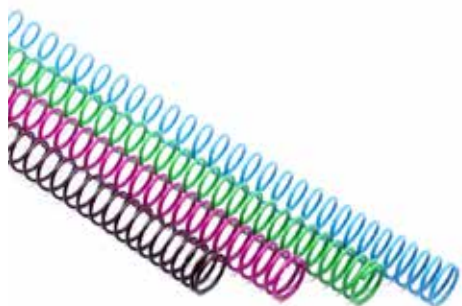

Choose your spring **color**



EEMANN TECH MAIN SPRING FOR 1911/2011

Reference nr.	Spring weight
ET-111160	14 lbs
ET-111161	15 lbs
ET-111162	16 lbs
ET-111163	17 lbs
ET-111164	18 lbs



EEMANN TECH MAGAZINE CATCH SPRING FOR 1911/2011

Reference nr.
ET-111080



EEMANN TECH MAGAZINE CATCH SPRING LIGHT FOR 1911/2011*

Reference nr.
ET-111081

* -15% less from ET-111080



EEMANN TECH MAIN SPRINGS CALIBRATION PACK FOR 1911/2011

Reference nr.	Spring weight	Color
ET-119012		
↳ ET-111160	14 lbs - 1 pc.	Blue
↳ ET-111161	15 lbs - 1 pc.	Red
↳ ET-111162	16 lbs - 1 pc.	Green
↳ ET-111163	17 lbs - 1 pc.	Yellow
↳ ET-111164	18 lbs - 1 pc.	Black

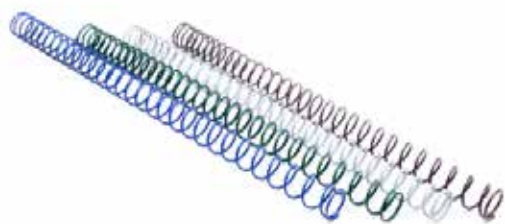

EEMANN TECH RECOIL SPRINGS CALIBRATION PACK "OPEN MAJOR" FOR 2011

Reference nr.	Spring weight	Color
ET-119001		
↳ ET-111326	6 lbs - 1 pc.	Blue
↳ ET-111327	7 lbs - 1 pc.	Green
↳ ET-111328	8 lbs - 1 pc.	Grey
↳ ET-111329	9 lbs - 1 pc.	Brown



EEMANN TECH RECOIL SPRINGS CALIBRATION PACK "STANDARD/CLASSIC MINOR" FOR 1911/2011

Reference nr.	Spring weight	Color
ET-119002		
↳ ET-111329	9 lbs - 1 pc.	Brown
↳ ET-111330	10 lbs - 1 pc.	Pink
↳ ET-111331	11 lbs - 1 pc.	Green
↳ ET-111332	12 lbs - 1 pc.	Blue



EEMANN TECH RECOIL SPRINGS CALIBRATION PACK "STANDARD MAJOR" FOR 2011

Reference nr.	Spring weight	Color
ET-119003		
↳ ET-111332	12 lbs - 1 pc.	Blue
↳ ET-111333	13 lbs - 1 pc.	Grey
↳ ET-111334	14 lbs - 1 pc.	Red
↳ ET-111335	15 lbs - 1 pc.	Orange



EEMANN TECH RECOIL SPRINGS CALIBRATION PACK "CLASSIC MAJOR" FOR 1911

Reference nr.	Spring weight	Color
ET-119004		
↳ ET-111335	15 lbs - 1 pc.	Orange
↳ ET-111336	16 lbs - 1 pc.	Pink
↳ ET-111337	17 lbs - 1 pc.	Yellow
↳ ET-111338	18 lbs - 1 pc.	Black

EEMANN TECH RECOIL SPRING FOR 1911/2011

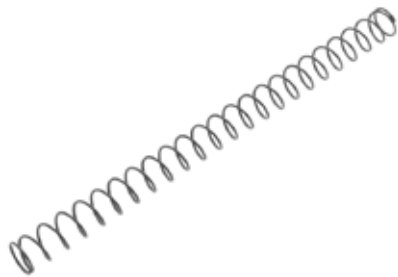

Reference nr.	Spring weight
ET-114106	6 lbs
ET-114108	8 lbs
ET-114110	10 lbs
ET-114112	12 lbs
ET-114114	14 lbs
ET-114116	16 lbs
ET-114118	18 lbs
ET-114120	20 lbs
ET-144122	22 lbs
ET-114122	24 lbs

EEMANN TECH SPRINGS KIT FOR 1911/2011



Reference nr.	
ET-119010	NEW



Eemann Tech Recoil Spring for 1911/2011 5" Barrel

Recoil springs are available in different power specifications for the recoil function to suit individual needs. Made of steel, with thermic treatment for the best performance and quality!



EEMANN TECH COMPETITION SPRINGS KIT FOR 1911/2011

Reference nr.

ET-119011

NEW



EEMANN TECH SAFETY LOCK PLUNGER SPRING FOR 1911/2011

Reference nr.

ET-111110



EEMANN TECH SEAR SPRING FOR 1911/2011

Reference nr.

ET-111200



EEMANN TECH COMPETITION SEAR SPRING FOR 1911/2011

Reference nr.

ET-111222

NEW



EEMANN TECH FIRING PIN SPRING FOR 1911/2011

Reference nr.

ET-111040



SPARE SPRING SET FOR EEMANN TECH COMPETITION EXTRACTOR 1911/2011

Reference nr.

ET-111033



EEMANN TECH 120 MM STANDARD MAGAZINE SPRING FOR 2011

Reference nr.

ET-111301





EEMANN TECH 140 MM HIGH CAPACITY
MAGAZINE SPRING FOR 2011

Reference nr.

ET-111304



EEMANN TECH 170 MM STANDARD MAGAZINE
SPRING FOR 2011

Reference nr.

ET-111305



EEMANN TECH 170 MM HIGH CAPACITY
MAGAZINE SPRING FOR 2011

Reference nr.

ET-111306



EEMANN TECH MAGAZINE SPRING FOR MBX STI
126MM MAGAZINE

Reference nr.

ET-111307

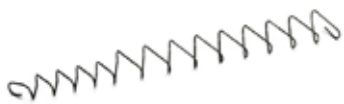

EEMANN TECH SINGLE STACK MAGAZINE SPRING
FOR 1911

Reference nr.

ET-111550

Caliber

.45AUTO

ET-111551

9×19mm



EEMANN TECH 120 MM HIGH CAPACITY
MAGAZINE SPRING FOR 2011

Reference nr.

ET-111302



EEMANN TECH 140 MM STANDARD MAGAZINE
SPRING FOR 2011

Reference nr.

ET-111303



EEMANN TECH HAMMER SPRING FOR TANFOGLIO

Reference nr.	Spring weight
ET-151432	12 lbs
ET-151433	13 lbs
ET-151430*	16 lbs

*Factory power



EEMANN TECH MAGAZINE SPRING FOR TANFOGLIO

Reference nr.	Caliber
ET-151610	9×19mm
ET-151611	.40S&W

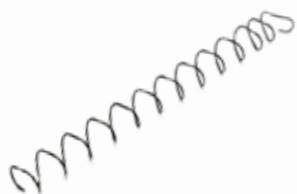

EEMANN TECH OPEN MAGAZINE SPRING 170 MM FOR TANFOGLIO

Reference nr.	Caliber
ET-151612	



EEMANN TECH RECOIL SPRING FOR TANFOGLIO

Reference nr.	Caliber
ET-151828	8 lbs
ET-151829	9 lbs
ET-151830	10 lbs
ET-151831	11 lbs
ET-151832	12 lbs
ET-151833	13 lbs
ET-151834	14 lbs
ET-151835	15 lbs
ET-151836	16 lbs
ET-151837	17 lbs



EEMANN TECH MAGAZINE CATCH SPRING FOR TANFOGLIO

Reference nr.
ET-151680



EEMANN TECH TRIGGER SPRING FOR TANFOGLIO

Reference nr.

ET-151330

EEMANN TECH COMPETITION TRIGGER SPRING
(-15% POWER) FOR TANFOGLIO***Reference nr.**

ET-151331

*15% less from factory power

EEMANN TECH EXTRACTOR SPRING FOR
TANFOGLIO**Reference nr.**

ET-151113

EEMANN TECH FIRING PIN SAFETY SPRING
FOR TANFOGLIO**Reference nr.**

ET-151560

EEMANN TECH FIRING PIN SPRING FOR
TANFOGLIO**Reference nr.**

ET-151530

EEMANN TECH COMPETITION FIRING PIN SPRING
FOR TANFOGLIO**Reference nr.**

ET-151540

NEW

EEMANN TECH SEAR SPRING FOR TANFOGLIO

Reference nr.

ET-151930

EEMANN TECH SPRINGS KIT FOR TANFOGLIO



Reference nr.

ET-151001

NEW

- ↳ ET-151835 - 1pc.
- ↳ ET-151430 - 1pc.
- ↳ ET-151330 - 1pc.
- ↳ ET-151530 - 1pc.
- ↳ ET-151930 - 1pc.
- ↳ ET-151680 - 1pc.
- ↳ ET-151560 - 1pc.
- ↳ ET-151113 - 1pc.

Compatible with:

- Tanfoglio STOCK II, III or similar
- Tanfoglio Xtreme II, III or similar

EEMANN TECH COMPETITION SPRINGS KIT FOR TANFOGLIO



Reference nr.

ET-152011

NEW

- ↳ ET-151830 - 1pc.
- ↳ ET-151433 - 1pc.
- ↳ ET-151331 - 1pc.
- ↳ ET-151530 - 1pc.
- ↳ ET-151930 - 1pc.
- ↳ ET-151680 - 1pc.
- ↳ ET-151560 - 1pc.
- ↳ ET-151113 - 1pc.

Compatible with:

- Tanfoglio STOCK II, III or similar
- Tanfoglio Xtreme II, III or similar

EEMANN TECH UPGRADE KIT FOR TANFOGLIO



Reference nr.

ET-150006

NEW



Eemann Tech Competition Springs Kit For GLOCK GEN5



EEMANN TECH COMPETITION SPRINGS KIT FOR GLOCK GEN5

Reference nr.

ET-121026

- ↳ ET-121003
- ↳ ET-121020
- ↳ ET-121005

The Eemann Tech GLOCK Competition Springs Kit allows you to lighten the trigger pull weight of your GLOCK GEN5

The GLOCK trigger pull weight is determined by spring weight and glock connector.

The Eemann Tech GLOCK GEN5 Competition Springs Kit contains:

- ET-121005 - Eemann Tech GLOCK Competition Firing Pin Safety Spring for Glock Gen5 (Reduced power) - lightens the work of the trigger mechanism.
- ET-121020 - Eemann Tech Competition Trigger Spring for GLOCK Gen5 - This spring helps you to pull the trigger easier.
- ET-121003 - Eemann Tech GLOCK Firing Pin Spring for GLOCK Gen3/4/5 4lbs (Reduced power) - lightens the work of the trigger mechanism.

NOTE: We cannot guarantee that the trigger safety will function correctly after installation of the whole kit, as the kit contains a competition spring.



EEMANN TECH COMPETITION FIRING PIN SPRING FOR GLOCK

Reference nr.	Spring weight
ET-121021	2,5 lbs
ET-121024	3 lbs
ET-121003	4 lbs



EEMANN TECH COMPETITION FIRING PIN SAFETY SPRING FOR GLOCK*

Reference nr.
ET-121005

*10% less from factory power



EEMANN TECH RECOIL SPRING FOR GLOCK 17-22-34-35

Reference nr.	Spring weight
ET-121010	10 lbs
ET-121011	11 lbs
ET-121012	12 lbs
ET-121013	13 lbs
ET-121014	14 lbs
ET-121015	15 lbs
ET-121016	16 lbs



EEMANN TECH MAGAZINE SPRING FOR 17 ROUNDS GLOCK 19-23 MAGAZINE

Reference nr.	Rounds amount
ET-121007	17
ET-121008	17+2
ET-121009	15
ET-121017	33



EEMANN TECH COMPETITION STRIKER SPRINGS PACK FOR GLOCK

Reference nr.	Spring weight	Color
ET-120030		<input type="checkbox"/>
↳ ET-121021	2.5 lbs	<input type="checkbox"/>
↳ ET-121024	3 lbs	<input checked="" type="checkbox"/>
↳ ET-121435	3.5 lbs	<input checked="" type="checkbox"/>
↳ ET-121003	4 lbs	<input checked="" type="checkbox"/>



EEMANN TECH COMPETITION SPRINGS KIT FOR GLOCK GEN 3/4

Reference nr.

ET-121018

↳ ET-121003

↳ ET-121004

↳ ET-121005



EEMANN TECH COMPETITION TRIGGER SPRING FOR GLOCK GEN5*

Reference nr.

ET-121020

*10% more power from factory spring



EEMANN TECH COMPETITION TRIGGER SPRING FOR GLOCK GEN 3/4*

Reference nr.

ET-121004

*10% more power from factory spring

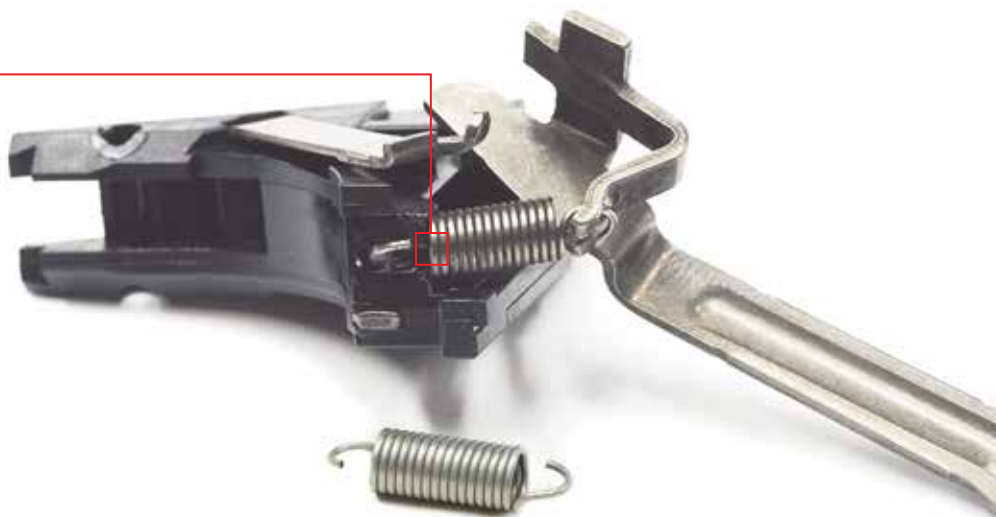

EEMANN TECH RECOIL SPRING FOR GLOCK 19-23



Reference nr.	Spring weight
ET-120190	10 lbs
ET-120191	11 lbs
ET-120192	12 lbs
ET-120193	13 lbs
ET-120194	14 lbs
ET-120195	15 lbs



EEMANN TECH TRIGGER SPRING FOR GLOCK GEN5

Reference nr.

ET-121030



EEMANN TECH COMPETITION SPRINGS KIT FOR GLOCK 43/43X

Reference nr.

ET-121043

↳ ET-121005

↳ ET-121020

↳ ET-121003



EEMANN TECH MAGAZINE CATCH SPRING FOR GLOCK

Reference nr.

ET-122013



EEMANN TECH SLIDE LOCK SPRING FOR
GLOCK 17

Reference nr.

ET-122014



EEMANN TECH TRIGGER SPRING FOR
GLOCK GEN 3/4

Reference nr.

ET-122017



EEMANN TECH SLIDE LOCK SPRING FOR
GLOCK 19

Reference nr.

ET-122022



EEMANN TECH MAGAZINE SPRING FOR
GLOCK 17 GEN 5

Reference nr.

ET-121031





EEMANN TECH TRIGGER BAR SPRING FOR
SIG SAUER P226

Reference nr.

ET-141001



EEMANN TECH HAMMER RESET SPRING FOR
SIG SAUER P226

Reference nr.

ET-141002



EEMANN TECH SEAR SPRING FOR SIG SAUER
P226

Reference nr.

ET-141003



EEMANN TECH FIRING PIN SPRING FOR
SIG SAUER P226

Reference nr.

ET-141004



EEMANN TECH TRIGGER BAR SPRING FOR
SIG SAUER P320

Reference nr.

ET-142004



EEMANN TECH SEAR SPRING FOR
SIG SAUER P320

Reference nr.

ET-142005



EEMANN TECH STRIKER SPRING FOR
SIG SAUER P320

Reference nr.

ET-142006



EEMANN TECH STRIKER SAFETY LOCK SPRING
FOR SIG SAUER P320

Reference nr.

ET-142007



EEMANN TECH TAKEDOWN SAFETY LEVEL
SPRING FOR SIG SAUER P320

Reference nr.

ET-142008



EEMANN TECH MAGAZINE CATCH SPRING FOR
SIG SAUER P320

Reference nr.

ET-142009



EEMANN TECH FIRING PIN SPRING LIGHT
(-15% POWER) FOR SIG SAUER P226*

Reference nr.

ET-141005*

15% less from ET-141004 (factory power)



EEMANN TECH MAIN SPRING FOR
SIG SAUER P226

Reference nr.

Spring weight

ET-141006 13 lbs

ET-141007 14 lbs

ET-141008 15 lbs

ET-141009 16 lbs

ET-141010 17 lbs

ET-141011* 19 lbs

*Factory power



EEMANN TECH RECOIL SPRING FOR
SIG SAUER P226

Reference nr.

Spring weight

ET-141012 9 lbs

ET-141013 10 lbs

ET-141014 11 lbs

ET-141015 12 lbs

ET-141016* 13 lbs

*Factory power



EEMANN TECH SLIDE CATCH LEVEL SPRING FOR
SIG SAUER P320

Reference nr.

ET-142002



EEMANN TECH SAFETY LEVER SPRING FOR
SIG SAUER P320

Reference nr.

ET-142003



EEMANN TECH MAIN SPRING FOR BERETTA
92/96/98

Reference nr.

ET-241024



EEMANN TECH FIRING PIN BLOCK SPRING FOR
BERETTA 92/96/98

Reference nr.

ET-241016

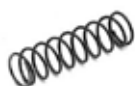

EEMANN TECH FIRING PIN SPRING FOR BERETTA
92/96/98

Reference nr.

ET-241015



EEMANN TECH RECOIL SPRING FOR BERETTA

Reference nr.

ET-241008



EEMANN TECH COMPETITION SEAR SPRING FOR
BERETTA 92/96/98

Reference nr.

ET-241048



EEMANN TECH COMPETITION SPRINGS KIT FOR BERETTA 92/96/98

Reference nr.

ET-242092

- ↳ ET-241045
- ↳ ET-241046
- ↳ ET-241047
- ↳ ET-241048
- ↳ ET-241009
- ↳ ET-241032

Compatible with:

- Beretta 92/96/98 and their models

All the springs in this kit are made for the best performance in competition and to produce better competition results.

If you're wanting to upgrade your Beretta 92/96/98 and their models for competition, this is the right kit for you.



EEMANN TECH SPRINGS KIT FOR BERETTA 92/96/98

Reference nr.

ET-242100

- ↳ ET-241013
- ↳ ET-241015
- ↳ ET-241016
- ↳ ET-241017
- ↳ ET-241018
- ↳ ET-241019
- ↳ ET-241020
- ↳ ET-241021
- ↳ ET-241022
- ↳ ET-241024
- ↳ ET-241023
- ↳ ET-241025
- ↳ ET-241026



EEMANN TECH COMPETITION TRIGGER BAR
SPRING FOR BERETTA 92/96/98

Reference nr.

ET-241047



EEMANN TECH COMPETITION TRIGGER SPRING
FOR BERETTA 92/96/98

Reference nr.

ET-241046



EEMANN TECH COMPETITION FIRING PIN SPRING
FOR BERETTA 92/96/98

Reference nr.

ET-241045



EEMANN TECH EXTRACTOR SPRING FOR BERETTA
92/96/98

Reference nr.

ET-241017



EEMANN TECH LEFT SAFETY PLUNGER SPRING
FOR BERETTA 92/96/98

Reference nr.

ET-241018



EEMANN TECH RIGHT SAFETY SPRING FOR
BERETTA 92/96/98

Reference nr.

ET-241026



EEMANN TECH DISASSEMBLY SPRING FOR
BERETTA 92/96/98

Reference nr.

ET-241019



EEMANN TECH SLIDE STOP SPRING FOR BERETTA
92/96/98

Reference nr.

ET-241020



EEMANN TECH TRIGGER SPRING FOR BERETTA
92/96/98

Reference nr.

ET-241021



EEMANN TECH TRIGGER BAR SPRING FOR
BERETTA 92/96/98

Reference nr.

ET-241022



EEMANN TECH MAGAZINE CATCH SPRING FOR
BERETTA 92/96/98

Reference nr.

ET-241023



EEMANN TECH SEAR SPRING FOR BERETTA
92/96/98

Reference nr.

ET-241025



Eemann Tech Competition Trigger Springs Kit for AR-15



Customize your **trigger**



EEMANN TECH COMPETITION TRIGGER SPRINGS KIT FOR AR-15

Reference nr.

ET-180001



EEMANN TECH TACTICAL TRIGGER SPRINGS KIT FOR AR-15

Reference nr.

ET-180002



EEMANN TECH COMPETITION TRIGGER SPRING FOR AR-15

Reference nr.

ET-180003



EEMANN TECH HAMMER SPRING FOR AR-15

Reference nr.

ET-180075



EEMANN TECH COMPETITION HAMMER SPRING FOR AR-15

Reference nr.

ET-180078



EEMANN TECH SMALL SPRINGS SET FOR AR-15

Reference nr.

ET-180030

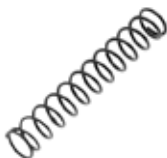

EEMANN TECH AR-15 RECOIL BUFFER RETAINER SPRING

Reference nr.

ET-180011



EEMANN TECH AR-15 MAGAZINE RELEASE SPRING

Reference nr.

ET-180012



EEMANN TECH AR-15 TAKEDOWN DETENT SPRING

Reference nr.

ET-180013



EEMANN TECH AR-15 SELECTOR DETENT SPRING

Reference nr.

ET-180014



EEMANN TECH AR-15 PIVOT DETENT SPRING

Reference nr.

ET-180015



EEMANN TECH AR-15 BOLT CATCH DETENT SPRING

Reference nr.

ET-180016



EEMANN TECH DISCONNECTOR SPRING FOR AR-15

Reference nr.

ET-180071



EEMANN TECH RECOIL BUFFER SPRING FOR AR-15

Reference nr.

ET-180006



EEMANN TECH EXTRACTOR SPRING FOR AR-15

Reference nr.

ET-180056



EEMANN TECH EJECTOR SPRING FOR AR-15

Reference nr.

ET-180052



EEMANN TECH CHARGING HANDLE LATCH SPRING FOR AR-15, AR-9

Reference nr.

ET-180091



EEMANN TECH AR-15 LOWER SMALL PARTS SET

Reference nr.

ET-180005

AR-9 PCC



EEMANN TECH FIRING PIN SPRING FOR AR-9 PCC

Reference nr.

ET-189003



EEMANN TECH SPRINGS KIT FOR MOLOT-VEPR 12GA

Reference nr.

ET-170012

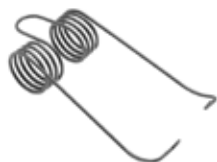

EEMANN TECH HAMMER SPRING FOR MOLOT-VEPR 12GA

Reference nr.

ET-170554



EEMANN TECH EXTRACTOR SPRING FOR MOLOT-VEPR 12GA

Reference nr.

ET-170060

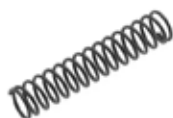

EEMANN TECH FIRING PIN SPRING FOR MOLOT-VEPR 12GA

Reference nr.

ET-170061



EEMANN TECH MAGAZINE CATCH SPRING FOR MOLOT-VEPR 12GA

Reference nr.

ET-170474



EEMANN TECH SLIDE LOCK SPRING FOR MOLOT-VEPR 12GA

Reference nr.

ET-170388



EEMANN TECH COMPETITION SPRINGS KIT FOR BENELLI

Reference nr.

ET-191001



EEMANN TECH HAMMER SPRING FOR BENELLI

Reference nr.

ET-191002



EEMANN TECH TRIGGER SPRING FOR BENELLI

Reference nr.

ET-191003



EEMANN TECH FIRING PIN SPRING FOR BENELLI

Reference nr.

ET-191004



EEMANN TECH RECOIL SPRING FOR BENELLI

Reference nr.

ET-191005



EEMANN TECH SHOTGUN EXTENSION TUBE SPRING FOR 12GA

Reference nr.

ET-121212



EEMANN TECH RECOIL SPRING FOR GRAND
POWER T10 / T12 / T910

Reference nr.

ET-190001



EEMANN TECH COMPETITION TRIGGER SPRINGS
KIT FOR GRAND POWER STRIBOG

Reference nr.

ET-190970



EEMANN TECH RECOIL SPRING FOR GRAND
POWER STRIBOG SP9 A3

Reference nr.

ET-190148



EEMANN TECH EXTRACTOR SPRING FOR GRAND
POWER STRIBOG

Reference nr.

ET-190153



EEMANN TECH FIRING PIN SPRING FOR GRAND
POWER STRIBOG

Reference nr.

ET-190161



EEMANN TECH SIGHT SPRING FOR GRAND
POWER STRIBOG

Reference nr.

ET-190157



EEMANN TECH HAMMER SPRING FOR GRAND
POWER STRIBOG

Reference nr.

ET-190133



EEMANN TECH MAGAZINE RELEASE SPRING FOR GRAND POWER STRIBOG

Reference nr.

ET-190143



EEMANN TECH TRIGGER SPRING FOR GRAND POWER STRIBOG

Reference nr.

ET-190130



EEMANN TECH DISCONNECTOR SPRING FOR GRAND POWER STRIBOG

Reference nr.

ET-190132



EEMANN TECH TRIGGER SPRING FOR GRAND POWER K100

Reference nr.

ET-190033



EEMANN TECH HAMMER CATCH SPRING FOR GRAND POWER K100

Reference nr.

ET-190026



EEMANN TECH BOLT CATCH SPRING FOR GRAND POWER STRIBOG

Reference nr.

ET-190139



EEMANN TECH AUTOSAFETY SPRING FOR GRAND POWER K100

Reference nr.

ET-190003



EEMANN TECH AUTOSAFETY SPRING FOR GRAND POWER K100

Reference nr.

ET-190003



EEMANN TECH EXTRACTOR SPRING FOR GRAND POWER K100

Reference nr.

ET-190046



EEMANN TECH FRONT TAKEDOWN PIN SPRING FOR GRAND POWER STRIBOG

Reference nr.

ET-190154



EEMANN TECH SPARE SPRINGS KIT FOR GRAND POWER STRIBOG

Reference nr.

ET-190101

Eemann Tech Springs Kit ET-190101 for Grand Power Stribog contains:

- ET-190130 - Eemann Tech Trigger Spring for Grand Power Stribog - 1 pc.
- ET-190132 - Eemann Tech Disconnecter Spring for Grand Power Stribog - 1 pc.
- ET-190133 - Eemann Tech Hammer Spring for Grand Power Stribog - 1 pc.
- ET-190139 - Eemann Tech Bolt Catch Spring for Grand Power Stribog - 1 pc.
- ET-190143 - Eemann Tech Magazine Release Spring for Grand Power Stribog - 1 pc.
- ET-190148 - Eemann Tech Recoil Spring FOR GRAND POWER STRIBOG SP9 A3 (Total length ~25cm (~9,7")) - 1 pc.
- ET-190153 - Eemann Tech Extractor Spring for Grand Power Stribog - 1 pc.
- ET-190154 - Eemann Tech Front Takedown Pin Spring for Grand Power Stribog - 1 pc.
- ET-190157 - Eemann Tech Sight Spring for Grand Power Stribog - 1 pc.
- ET-190161 - Eemann Tech Firing Pin Spring for Grand Power Stribog - 1 pc.



EEMANN TECH SPRINGS KIT FOR DILLON RL550

Reference nr.

ET-520048



EEMANN TECH EJECTOR WIRE 13925 FOR DILLON RL550

Reference nr.

ET-513925



EEMANN TECH PRIMER CUP SPRING 14033 FOR DILLON XL550/XL650

Reference nr.

ET-514033



EEMANN TECH RETAINING CLIPS 10-PACK FOR DILLON 14040 PICKUP TUBE

Reference nr.

ET-514040



EEMANN TECH SPRINGS KIT FOR DILLON XL650/XL750

Reference nr.

ET-521146



EEMANN TECH EJECTOR WIRE 13298 FOR DILLON XL650/XL750

Reference nr.

ET-513298



EEMANN TECH INDEXER RETURN SPRING 13791 FOR DILLON XL650/XL750

Reference nr.

ET-513791



EEMANN TECH LOCATOR TAB SPRING 13624 FOR DILLON XL650

Reference nr.

ET-513624



EEMANN TECH PAWL SPRING 13938 FOR DILLON XL650/XL750

Reference nr.

ET-513938



EEMANN TECH DISC DETENT SPRING 13844 FOR DILLON XL650

Reference nr.

ET-513844



EEMANN TECH INDEX BALL SPRING 13997 FOR DILLON XL650/XL750

Reference nr.

ET-513997



EEMANN TECH INDEXING ARM SPRING 13965 FOR DILLON XL650

Reference nr.

ET-513965



EEMANN TECH CASEFEED ARM RETURN SPRING 13936 FOR DILLON XL650/XL750

Reference nr.

ET-513936



EEMANN TECH CASE INSERT SLIDE SPRING 13937 FOR DILLON XL650/XL750

Reference nr.

ET-513937



EEMANN TECH SPRINGS KIT 75111 FOR
DILLON XL750

Reference nr.

ET-575111



EEMANN TECH PRIMER PUNCH SPRING
62328 FOR DILLON XL750

Reference nr.

ET-562328



EEMANN TECH STATION 2 LOCATOR SPRING
62331 FOR DILLON XL750

Reference nr.

ET-562331



EEMANN TECH SPRINGS KIT FOR DILLON
RL1050

Reference nr.

ET-501050



EEMANN TECH PRIMER PUNCH SPRING
13858 FOR DILLON 1050

Reference nr.

ET-513858



EEMANN TECH TOOLHEAD SPRING 8,5"
A12572 FOR DILLON RL1050*

Reference nr.

ET-512572

*For Dillon RL1050 machines produced before January 2016 (older models)



EEMANN TECH TOOLHEAD SPRING 10,5" 12572
FOR DILLON RL1050*

Reference nr.

ET-512570

*For Dillon RL1050 machines produced after January 2016 (modern models)



EEMANN TECH DECAPPING PINS 10 PCS. PACK
FOR DILLON DIES

Reference nr.

ET-513753



EEMANN TECH INDEXER RETURN SPRING FOR
DILLON 1050, SQUAREB

Reference nr.

ET-513944



EEMANN TECH SLIDE RETURN SPRING 13928 FOR
DILLON RL550

Reference nr.

ET-513928



EEMANN TECH CARTRIDGE SPRING 13926 FOR
DILLON RL550

Reference nr.

ET-513926



EEMANN TECH POWDER MEASURE RETURN
SPRINGS SET FOR DILLON

Reference nr.

ET-512001





EEMANN TECH SPRINGS KIT FOR PHOENIX REDBACK

Reference nr.

ET-169000



EEMANN TECH FIRING PIN SPRING FOR PHOENIX REDBACK

Reference nr.

ET-169001



EEMANN TECH MAIN SPRING FOR PHOENIX REDBACK

Reference nr.

Spring weight

ET-169014 10 lbs

ET-169015 9 lbs

ET-169016 8 lbs



EEMANN TECH RECOIL SPRING FOR PHOENIX REDBACK

Reference nr.

Spring weight

ET-169003 13 lbs

ET-169004 12 lbs

ET-169005 11 lbs

ET-169006 10 lbs



EEMANN TECH SEAR SPRING FOR PHOENIX REDBACK

Reference nr.

ET-169012



EEMANN TECH TRIGGER SPRING FOR PHOENIX REDBACK

Reference nr.

ET-169010



EEMANN TECH COMPETITION SEAR SPRING (-10% POWER) FOR PHOENIX REDBACK

Reference nr.

ET-169013



EEMANN TECH COMPETITION TRIGGER SPRING FOR PHOENIX REDBACK

Reference nr.

ET-169011



EEMANN TECH COMPETITION FIRING PIN SPRING FOR PHOENIX

Reference nr.

ET-169019

NEW



EEMANN TECH COMPETITION SPRINGS KIT FOR PHOENIX

Reference nr.

ET-169020

NEW

This competition kit includes 11lbs recoil spring for optimal recoil management and a selection of main springs in 3 different powers (6, 7, and 8 lbs). This variety allows shooters to finely calibrate their firearm for perfect harmony with their specific pistol and ammunition, ensuring peak performance and reliability in competitive environments.

The Eemann Tech Competition Springs Kit for Phoenix includes:

- ET-169005 - Eemann Tech Recoil Spring for Phoenix - 11lbs - 1 pc.
- ET-169011 - Eemann Tech Competition Trigger Spring for Phoenix - 1 pc.
- ET-169013 - Eemann Tech Competition Sear Spring for Phoenix - 1 pc.
- ET-169019 - Eemann Tech Competition Firing Pin Spring for Phoenix - 1 pc.
- ET-169018 - Eemann Tech Main Spring for Phoenix 6 lbs - 1 pc. (marked with Yellow color)
- ET-169017 - Eemann Tech Main Spring for Phoenix 7 lbs - 1 pc. (marked with Red color)
- ET-169016 - Eemann Tech Main Spring for Phoenix 8 lbs - 1 pc. (no color marked)



EEMANN TECH TRIGGER SPRING
FOR WALTHER PPQ/PDP

Reference nr.

ET-249001

NEW



EEMANN TECH COMPETITION TRIGGER SPRING
FOR WALTHER PPQ/PDP

Reference nr.

ET-249002

NEW



EEMANN TECH MAGAZINE SPRING +2
FOR WALTHER PPQ, P99, Q5 MATCH SF

Reference nr.

ET-249508

NEW



EEMANN TECH SAFETY PLUNGER SPRING
FOR WALTHER PDP/Q-SERIES

Reference nr.

ET-249095

NEW



EEMANN TECH EXTRACTOR SPRING
FOR WALTHER P99/PPQ

Reference nr.

ET-249014

NEW



EEMANN TECH SLIDE STOP LEVER SPRING
FOR WALTHER Q5 MATCH SF

Reference nr.

ET-249051

NEW



EEMANN TECH SPRINGS SET FOR UPLULA SPEEDLOADER

Reference nr.

ET-040015

S.P.S



EEMANN TECH MAIN SPRING FOR SPS

Reference nr.

Spring weight

ET-111165

13 lbs

ET-111166*

16 lbs

*Factory power



EEMANN TECH COMPETITION TRIGGER SPRING FOR KMR



Reference nr.

ET-134700

NEW

EEMANN TECH COMPETITION SEAR SPRING FOR KMR



Reference nr.

ET-134701

NEW

EEMANN TECH COMPETITION FIRING PIN SPRING FOR KMR



Reference nr.

ET-134703

NEW

EEMANN TECH MAIN SPRING FOR KMR



Reference nr.

Spring weight

ET-134707

7 lbs

NEW

ET-134708

8 lbs

NEW

ET-134709

9 lbs

NEW

ET-134710

10 lbs

NEW

EEMANN TECH RECOIL SPRING FOR KMR UMBRA 4,5"



Reference nr.

Spring weight

ET-134723

8 lbs

NEW

ET-134724

10 lbs

NEW

ET-134725

12 lbs

NEW

ET-134726

14 lbs

NEW

ET-134727

16 lbs

NEW



EEMANN TECH RECOIL SPRING FOR KMR SPECTRA 5"

Reference nr.	Spring weight	
ET-134712	7 lbs	NEW
ET-134713	8 lbs	NEW
ET-134714	9 lbs	NEW
ET-134715	10 lbs	NEW
ET-134716	11 lbs	NEW
ET-134717	12 lbs	NEW
ET-134718	13 lbs	NEW

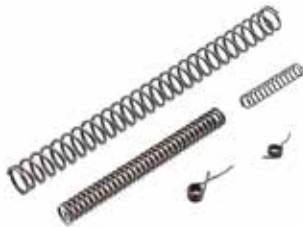

EEMANN TECH COMPETITION SPRINGS KIT FOR KMR 4.5"

Reference nr.	
ET-134704	NEW

Eemann Tech Competition Springs Kit ET-134704 for KMR 4.5" contains:

ET-134725 Eemann Tech Recoil Spring for KMR 4.5" 12lbs - 1pc.
 ET-134708 Eemann Tech Main Spring for KMR 8lbs - 1pc.
 ET-134700 Eemann Tech Competition Trigger Spring for KMR - 1pc.
 ET-134703 Eemann Tech Competition Firing Pin Spring for KMR - 1pc.
 ET-134701 Eemann Tech Competition Sear Spring for KMR - 1pc.

Compatible with:

KMR L-02 4.5" and their models
 KMR W-02 4.5" and their models



EEMANN TECH COMPETITION SPRINGS KIT FOR KMR 5"

Reference nr.	
ET-134705	NEW

Eemann Tech Competition Springs Kit ET-134705 for KMR 5" contains:

ET-134717 Eemann Tech Recoil Spring for KMR 5" 12lbs - 1pc.
 ET-134708 Eemann Tech Main Spring for KMR 8lbs - 1pc.
 ET-134700 Eemann Tech Competition Trigger Spring for KMR - 1pc.
 ET-134703 Eemann Tech Competition Firing Pin Spring for KMR - 1pc.
 ET-134701 Eemann Tech Competition Sear Spring for KMR - 1pc.

Compatible with:

KMR L-02 5" and their models
 KMR W-02 5" and their models



Eemann Tech produces standard and tuning parts for the most popular handguns, shotguns, and rifles amongst Practical Shooting competitors:

1911/2011, CZ, GLOCK, Sig Sauer, Sphinx, AR15 and other firearm models and types.



We make spare parts of excellent quality, exceeding the quality of factory-made standard parts.

We pay special attention to the tuning parts. While developing parts we use the long-term experience of the best Practical Shooting competitors around the world. All parts are made of high quality materials using modern and advanced technology.

Every competitor is able to customize their shooting equipment using the Eemann Tech parts according to their needs and division. We have everything for making handguns meet the factory parameters using Eemann Tech classic-line spare parts or make them highly customized by using the Eemann Tech

tuning-line parts.

We produce trigger mechanisms, enhanced slide stops and thumb safeties; sport extended magazine catches, front and rear sights; main, trigger, sear and recoil springs, recoil spring guide rods and many other parts that are needed and wanted among the competitive shooters all over the world.

All parts are labeled and packed accordingly.

GUN PARTS

All Eemann Tech parts are fully CNC-machined (MIM FREE).



Eemann Tech Extended Firing Pin for 1911/2011

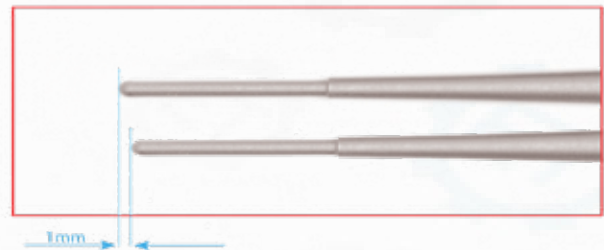
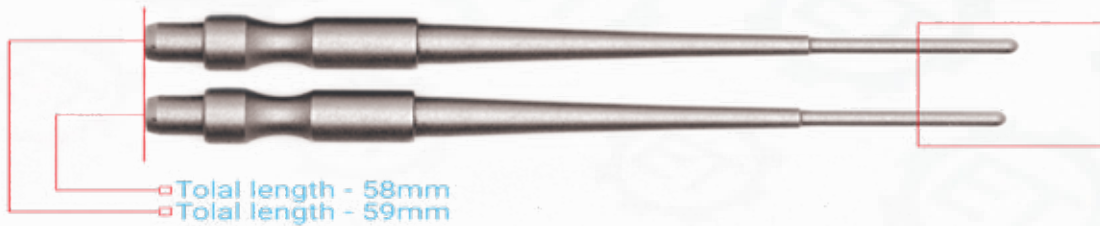

Control your speed



EEMANN TECH FIRING PIN FOR 1911/2011

Reference nr.	Caliber	Color
ET-112050	9mm/.38S/.40S&W	Silver



EEMANN TECH EXTENDED FIRING PIN FOR 1911/2011

Reference nr.	Caliber	Color
ET-112052	9mm/.38S/.40S&W	Silver



EEMANN TECH COMPETITION EXTRACTOR FOR 1911/2011

Reference nr.	Caliber	Color
ET-111034	9mm/.40S&W	Black



SPARE SPRING CAP FOR EEMANN TECH COMPETITION EXTRACTOR 1911/2011

Reference nr.
ET-111035



EEMANN TECH EXTRACTOR FOR 1911/2011

Reference nr.	Caliber	Color
ET-111030	9mm/.40S&W	Black
ET-111031	.45auto	Black
ET-111032	.45auto 80 Series	Black



EEMANN TECH MAGAZINE CATCH PLAIN FOR 1911*

Reference nr.	Color
ET-111090	Black
ET-111091	Silver

*Catch lock and catch spring not included



EEMANN TECH MAGAZINE CATCH WITH EXTENDED BUTTON FOR 1911*

Reference nr.	Color
ET-111092	Black
ET-111093	Silver

*Catch lock and catch spring not included



EEMANN TECH MAGAZINE CATCH PLAIN FOR 2011*

Reference nr.	Color
ET-111094	Black
ET-111095	Silver

*Catch lock and catch spring not included



EEMANN TECH MAGAZINE CATCH WITH EXTENDED BUTTON FOR 2011*

Reference nr.	Color
ET-111096	Black
ET-111097	Silver

*Catch lock and catch spring not included



EEMANN TECH MAGAZINE CATCH LOCK FOR 1911/2011

Reference nr.	Color
ET-111070	Black
ET-111071	Silver



EEMANN TECH EXTENDED SLIDE STOP FOR 1911*

Reference nr.	Color
ET-211291	Black
ET-212281	Silver

* For calibers 9×19mm, .45



EEMANN TECH SOLID SLIDE STOP FOR 1911/2011*

Reference nr.	Color
ET-211290	Black
ET-212290	Silver

* For calibers 9×19mm, .40S&W, .45



EEMANN TECH SLIDE STOP PLUNGER FOR 1911/2011

Reference nr.	Color
ET-111100	Black
ET-112100	Silver



EEMANN TECH SAFETY LOCK PLUNGER FOR 1911/2011

Reference nr.	Color
ET-111120	Black
ET-112120	Silver



EEMANN TECH PLUNGER TUBE FOR 1911/2011

Reference nr.	Color
ET-111440	Black



EEMANN TECH THUMB REST SLIDE STOP FOR 1911/2011

Reference nr.	Color
ET-212292	Silver
ET-211293	Black



EEMANN TECH SOLID SAFETY FOR 1911/2011

Reference nr.	Color
ET-111260	Black
ET-111261	Silver



EEMANN TECH SOLID COMBAT SINGLE SAFETY FOR 1911

Reference nr.	Color
ET-111262	Black
ET-111263	Silver



EEMANN TECH SOLID WIDE SINGLE SAFETY FOR 1911

Reference nr.	Color
ET-111264	Black
ET-111265	Silver



EEMANN TECH SOLID COMBAT SAFETY FOR 1911/2011

Reference nr.	Color
ET-111266	Black
ET-111267	Silver



EEMANN TECH COMPETITION THUMB SAFETY WITH SHIELD FOR 1911/2011

Reference nr.
ET-211929



EEMANN TECH TRIGGER FOR 2011

Reference nr.	Color
ET-111196	Black
ET-111197	Silver

Trigger full length: 56,5mm



EEMANN TECH TRIGGER FOR 1911

Reference nr.	Color
ET-111140	Black
ET-111143	Silver

Trigger full length: 56,5mm



EEMANN TECH K-HOLE TRIGGER FOR 1911

Reference nr.	Color
ET-111141	Black
ET-111142	Silver

Trigger full length: 56,7mm



EEMANN TECH SOLID TRIGGER FOR 2011

Reference nr.	Color
ET-111145	Silver

Trigger full length: 51,2mm



EEMANN TECH SOLID TRIGGER LONG FOR 2011

Reference nr.	Color
ET-111147	Silver

Trigger full length: 56,6mm



EEMANN TECH K-HOLE FLAT TRIGGER FOR 2011

Reference nr.	Color
ET-111148	Black
ET-111149	Silver

Trigger full length: 57,8mm



EEMANN TECH K-HOLE TRIGGER FOR 2011

Reference nr.	Color
ET-111198	Black
ET-111199	Silver

Trigger full length: 56,7mm



EEMANN TECH ULTRA LIGHT COMPETITION HAMMER FOR 1911/2011 - BLACK

Reference nr.

ET-111405



EEMANN TECH PINS SET FOR 2011

Reference nr.

Color

ET-111603

Black

ET-111604

Silver



EEMANN TECH TWO PIECES MAGWELL FOR 1911, 25LPI CHECKERED

Reference nr.

Color

Height

ET-111180

Black

47,2 mm

ET-111181

Silver

47,2 mm

Magwell size: 32×48×5mm



EEMANN TECH MAINSPRING HOUSING FOR 1911, 25LPI CHECKERED, FLAT*

Reference nr.

Color

Height

ET-111192

Black

48,6 mm

ET-111191

Silver

48,6 mm

*For installation without magwell



EEMANN TECH SLIDE STOP WITH THUMB REST FOR 1911/2011

Reference nr.	Color
ET-111295	Black
ET-111296	Silver

Eemann Tech Slide Stop with Thumb Rest is made from one piece of carbon steel and CNC machined to the highest standards.

It is designed to be used with 1911/2011 firearms and their clones.

Advantages:

- No firearm modification required
- No fitting required and instant installation
- Provides stability and consistent grip for recoil control
- Slide stop thumb rest functions as a normal slide stop allowing slide to lock back if required
- When installed, fits in the IPSC Standard gun box
- Legal in IPSC Standard and Open divisions, Fits in IPSC Standard Box

Total width: ~37,5mm (1,475")

Thumb rest width: ~12,95mm (~0,5")

Weight: ~22 g





EEMANN TECH SLIDE STOP WITH THUMB REST FOR 1911/2011

Reference nr.	Color
ET-211293	Black
ET-212292	Silver

Eemann Tech Thumb Rest Slide Stop For Colt 1911, 2011 and clones.

Material: Stainless Steel

Caliber: All

All the EEMANN TECH parts for Colt 1911, STI 2011 and their clones are made from high quality carbon, alloyed or stainless steel using technologies and CNC machines of new generation.







Eemann Tech Front Sight for 1911/2011, Checked With 1mm Fiber Optics Rod

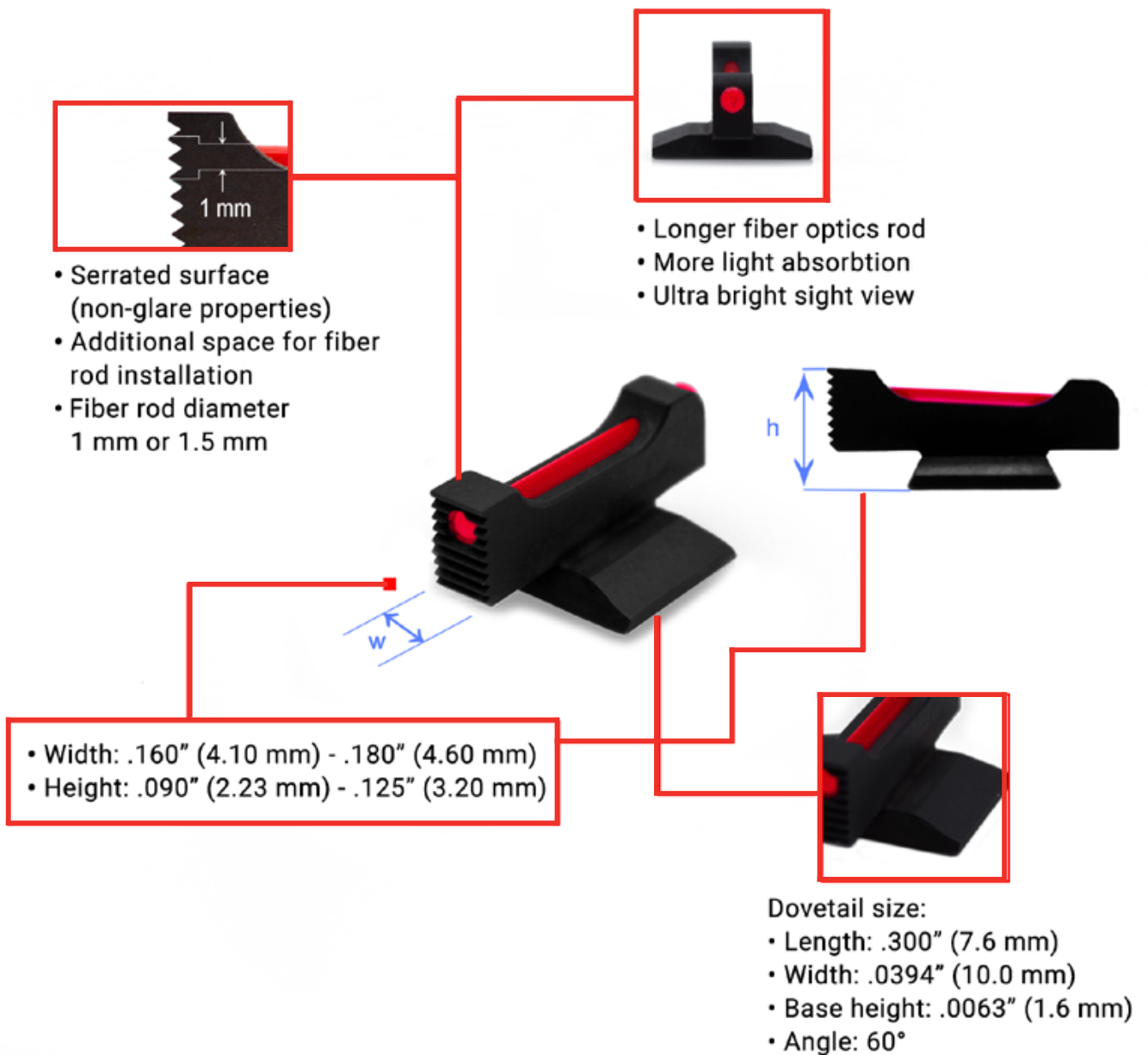

Perfection in every detail



EEMANN TECH FRONT SIGHT FOR 1911/2011,
CHECKERED, STEEL

Reference nr.	Height	Width
ET-130400	.180" (4.60mm)	.125" (3.20mm)
ET-130401	.180" (4.60mm)	.110" (2.80mm)
ET-130402	.180" (4.60mm)	.100" (2.56mm)
ET-130403	.180" (4.60mm)	.090" (2.23mm)
ET-130404	.160" (4.10mm)	.125" (3.20mm)
ET-130405	.160" (4.10mm)	.110" (2.80mm)
ET-130406	.160" (4.10mm)	.100" (2.56mm)
ET-130407	.160" (4.10mm)	.090" (2.23mm)



EEMANN TECH FRONT SIGHT FOR 1911/2011,
CHECKERED WITH 1MM FIBER OPTICS ROD

Reference nr.	Height	Width
ET-130408	.180" (4.60mm)	.125" (3.20mm)
ET-130409	.180" (4.60mm)	.110" (2.80mm)
ET-130410	.180" (4.60mm)	.100" (2.56mm)
ET-130411	.180" (4.60mm)	.090" (2.23mm)
ET-130412	.160" (4.10mm)	.125" (3.20mm)
ET-130413	.160" (4.10mm)	.110" (2.80mm)
ET-130414	.160" (4.10mm)	.100" (2.56mm)
ET-130415	.160" (4.10mm)	.090" (2.23mm)



EEMANN TECH FRONT SIGHT FOR 1911/2011,
CHECKERED WITH 1,5MM FIBER OPTICS ROD

Reference nr.	Height	Width
ET-130416	.180" (4.60mm)	.125" (3.20mm)
ET-130417	.180" (4.60mm)	.110" (2.80mm)
ET-130418	.180" (4.60mm)	.100" (2.56mm)
ET-130419	.160" (4.10mm)	.125" (3.20mm)
ET-130420	.160" (4.10mm)	.110" (2.80mm)
ET-130421	.160" (4.10mm)	.100" (2.56mm)



EEMANN TECH ADJUSTABLE REAR SIGHT BOMAR
FOR 1911/2011

Reference nr.
ET-111600





EEMANN TECH MAINSPRING HOUSING PIN FOR 1911

Reference nr.	Color
ET-111220	Black
ET-112220	Silver



EEMANN TECH MAINSPRING CAP FOR 1911/2011

Reference nr.	Color
ET-111150	Black
ET-112150	Silver



EEMANN TECH MAINSPRING HOUSING PIN RETAINER FOR 1911/2011

Reference nr.	Color
ET-111170	Black
ET-112170	Silver





EEMANN TECH MAINSPRING CAP PIN FOR 1911/2011

Reference nr.	Color
ET-111190	Black
ET-112190	Silver



EEMANN TECH HAMMER PIN FOR 1911/2011

Reference nr.	Color
ET-111270	Black
ET-112270	Silver



EEMANN TECH HAMMER STRUT PIN FOR 1911/2011

Reference nr.	Color
ET-111420	Black
ET-112420	Silver



EEMANN TECH BARREL LINK PIN FOR 1911/2011

Reference nr.	Color
ET-111360	Black
ET-112360	Silver



EEMANN TECH SEAR PIN FOR 1911/2011

Reference nr.	Color
ET-111280	Black
ET-112280	Silver



EEMANN TECH HAMMER STRUT FOR 1911/2011

Reference nr.	Color
ET-111410	Black



EEMANN TECH DEMON HAMMER FOR 1911/2011

Reference nr.	Color
ET-111400	Silver
ET-111409	Black



EEMANN TECH PREMIUM MATCH HAMMER FOR 1911/2011

Reference nr.	Color
ET-111401	Silver



EEMANN TECH COMMANDER HAMMER FOR 1911/2011

Reference nr.	Color
ET-111402	Silver
ET-111406	Black



EEMANN TECH PRO HAMMER FOR 1911/2011

Reference nr.	Color
ET-111403	Silver
ET-111408	Black



EEMANN TECH ULTRA LIGHT COMPETITION HAMMER FOR 1911/2011

Reference nr.	Color
ET-111404	Silver



EEMANN TECH RECOIL SPRING GUIDE ROD FOR 1911/2011

Reference nr.	Barrel Length
ET-111311	4.0"
ET-111310	5.0"
ET-111312	6.0"



EEMANN TECH COMPETITION GUIDE ROD TOOL-LESS FOR 1911/2011*

Reference nr.
ET-110001

*Recoil Spring is not included



EEMANN TECH COMPETITION SEAR FOR 1911/2011

Reference nr.	Material
ET-112390	Stainless Steel
ET-111390	Steel



9×19 mm

.40S&W

.45auto

EEMANN TECH EJECTOR FOR 1911/2011

Reference nr.	Caliber
ET-111450	9×19 mm
ET-111451	.40S&W
ET-111452	.45auto



EEMANN TECH PINS SET FOR 1911

Reference nr.	Color
ET-111601	Black
ET-111602	Silver



EEMANN TECH BARREL BUSHING FOR 1911

Reference nr.	Length	Color
ET-111340	21,1 mm	Silver
ET-111341	12,8 mm	Silver
ET-111342	21,1 mm	Black
ET-111343	12,8 mm	Black



EEMANN TECH RECOIL SPRING PLUG BUSHING BARREL FOR 1911/2011

Reference nr.	Color
ET-111316	Black
ET-111317	Silver



EEMANN TECH BARREL LINK FOR 1911/2011

Reference nr.	Size
ET-111371	#1
ET-111372	#2
ET-111373	#3
ET-111374	#4
ET-111375	#5



EEMANN TECH DISCONNECTOR FOR 1911/2011

Reference nr.	Color
ET-111380	Black



EEMANN TECH COMPETITION BUFFERS 5 PCS. SET FOR 1911/2011

Reference nr.
ET-303011



EEMANN TECH EJECTOR PIN FOR 1911/2011

Reference nr.	Color
ET-111460	Black
ET-112460	Silver

Diameter: 0,05" (1,5mm)



EEMANN TECH MAINSPRING HOUSING FLAT FOR 2011, CHECKERED 25 LPI

Reference nr.	Color
ET-111184	Black
ET-111185	Silver



EEMANN TECH MAGWELL FOR 2011

Reference nr.	Color
ET-211180	Black
ET-212180	Silver



EEMANN TECH MAINSPRING HOUSING PIN FOR 2011

Reference nr.	Color
ET-212220	Silver
ET-211220	Black



Eemann Tech Front Sight for CZ 75, Checked With 1mm Fiber Optics Rod



Sight your picture



EEMANN TECH CZ 75 FRONT SIGHT, CHECKERED, STEEL

Reference nr.	Height	Width
ET-130100	5,50 mm	3,00 mm
ET-130101	6,00 mm	3,00 mm
ET-130102	6,50 mm	3,00 mm
ET-130103	7,00 mm	3,00 mm
ET-130104	7,50 mm	3,00 mm
ET-130105	8,00 mm	3,00 mm



EEMANN TECH FRONT SIGHT FOR CZ 75, CHECKERED WITH 1MM FIBER OPTICS ROD

Reference nr.	Height	Width
ET-130200	5,00 mm	2,70 mm
ET-130201	5,00 mm	3,00 mm
ET-130202	5,25 mm	2,70 mm
ET-130203	5,25 mm	3,00 mm
ET-130326	5,50 mm	2,40 mm
ET-130204	5,50 mm	2,70 mm
ET-130205	5,50 mm	3,00 mm
ET-130206	5,75 mm	2,70 mm
ET-130207	5,75 mm	3,00 mm
ET-130208	6,00 mm	2,70 mm
ET-130209	6,00 mm	3,00 mm
ET-130210	6,25 mm	2,70 mm
ET-130211	6,25 mm	3,00 mm
ET-130212	6,50 mm	2,70 mm
ET-130213	6,50 mm	3,00 mm
ET-130214	6,75 mm	2,70 mm
ET-130215	6,75 mm	3,00 mm
ET-130216	7,00 mm	2,70 mm
ET-130217	7,00 mm	3,00 mm
ET-130218	7,25 mm	2,70 mm
ET-130219	7,25 mm	3,00 mm
ET-130220	7,50 mm	2,70 mm
ET-130221	7,50 mm	3,00 mm
ET-130222	7,75 mm	2,70 mm
ET-130223	7,75 mm	3,00 mm
ET-130224	8,00 mm	2,70 mm
ET-130225	8,00 mm	3,00 mm
ET-130226	9,50 mm	3,00 mm





EEMANN TECH FRONT SIGHT FOR CZ 75, CZ SHADOW 2 CHECKERED WITH 1,5 MM FIBER OPTICS ROD



Reference nr.	Height	Width
ET-130304	5,50 mm	2,70 mm
ET-130305	5,50 mm	3,00 mm
ET-130306	5,75 mm	2,70 mm
ET-130307	5,75 mm	3,00 mm
ET-130308	6,00 mm	2,70 mm
ET-130309	6,00 mm	3,00 mm
ET-130310	6,25 mm	2,70 mm
ET-130311	6,25 mm	3,00 mm
ET-130312	6,50 mm	2,70 mm
ET-130313	6,50 mm	3,00 mm
ET-130314	6,75 mm	2,70 mm
ET-130315	6,75 mm	3,00 mm
ET-130316	7,00 mm	2,70 mm
ET-130317	7,00 mm	3,00 mm
ET-130318	7,25 mm	2,70 mm
ET-130319	7,25 mm	3,00 mm
ET-130320	7,50 mm	2,70 mm
ET-130321	7,50 mm	3,00 mm
ET-130322	7,75 mm	2,70 mm
ET-130323	7,75 mm	3,00 mm
ET-130324	8,00 mm	2,70 mm
ET-130325	8,00 mm	3,00 mm





EEMANN TECH ADJUSTABLE REAR SIGHT
FOR CZ 75

Reference nr.

ET-130500



EEMANN TECH ADJUSTABLE REAR SIGHT WITH
FIBER OPTICS FOR CZ 75

Reference nr.

ET-130600



EEMANN TECH COMPETITION FRONT SIGHT FOR
CZ P-10

Reference nr.

ET-130071



EEMANN TECH ADJUSTABLE SIGHTS SET FOR
CZ P-10

Reference nr.

ET-130070



EEMANN TECH ADJUSTABLE REAR SIGHT FOR CZ
P-10

Reference nr.

ET-130074



EEMANN TECH ADJUSTABLE REAR SIGHT
FOR CZ SP-01 SHADOW

Reference nr.

ET-130008



EEMANN TECH ADJUSTABLE REAR SIGHT WITH
FIBER OPTICS FOR CZ SP-01 SHADOW

Reference nr.

ET-012025



EEMANN TECH ADJUSTABLE REAR SIGHT
FOR CZ 75 TS

Reference nr.

ET-130030



EEMANN TECH ADJUSTABLE REAR SIGHT WITH
FIBER OPTICS FOR CZ 75 TS

Reference nr.

ET-130031



EEMANN TECH ADJUSTABLE SIGHTS SET FOR CZ SHADOW

Reference nr.	Diameter
ET-130113	1,0 mm
ET-130114	1,5 mm

The set of Eemann Tech Adjustable Sights for CZ Shadow has been designed specifically for IPSC or Target Shooting disciplines (USPSA, IPSC, IDPA, Steel Challenge, ISSF).

This adjustable rear sight is intended only for CZ 75 SP-01 SHADOW and CZ SHADOW 2 pistols.

One click of vertical or horizontal adjusting screw corresponds approximately to 1 cm on the target at distance of 25 m (sights radius on CZ SP-01 SHADOW is 17 cm).

The height of the front end of the Eemann Tech CZ 75 Front Sight is lower than its back end for making the visible side of the sight sharper while aiming.





THE EEMANN TECH TRIGGER FOR CZ 75 (SINGLE ACTION ONLY)

BACK-SHIFTED

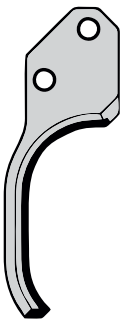

STRAIGHT



HOOKED



FRONT-SHIFTED



EXTRA FRONT-SHIFTED

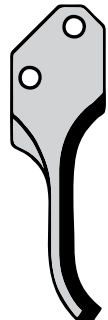

BLUE



RED



BLACK



SILVER



GOLD



EEMANN TECH TRIGGER FOR CZ 75, STRAIGHT

Reference nr.	Colour	Type
ET-012101	Blue	Smooth
ET-012103	Red	Smooth
ET-012104	Black	Smooth
ET-012105	White	Smooth
ET-012106	Yellow	Smooth



Reference nr.	Colour	Type
ET-012108	Blue	Serrated
ET-012110	Red	Serrated
ET-012111	Black	Serrated
ET-012112	White	Serrated
ET-012113	Yellow	Serrated



EEMANN TECH TRIGGER FOR CZ 75, HOOKED

Reference nr.	Colour	Type
ET-012115	Blue	Smooth
ET-012117	Red	Smooth
ET-012118	Black	Smooth
ET-012119	White	Smooth
ET-012120	Yellow	Smooth



Reference nr.	Colour	Type
ET-012122	Blue	Serrated
ET-012124	Red	Serrated
ET-012125	Black	Serrated
ET-012126	White	Serrated
ET-012127	Yellow	Serrated



EEMANN TECH TRIGGER FOR CZ 75, BACK-SHIFTED

Reference nr.	Colour	Type
ET-012143	Blue	Smooth
ET-012145	Red	Smooth
ET-012146	Black	Smooth
ET-012147	Grey	Smooth
ET-012148	Yellow	Smooth



Reference nr.	Colour	Type
ET-012150	Blue	Serrated
ET-012152	Red	Serrated
ET-012153	Black	Serrated
ET-012154	Grey	Serrated
ET-012155	Yellow	Serrated



EEMANN TECH TRIGGER FOR CZ 75, FRONT-SHIFTED

Reference nr.	Colour	Type
ET-012129	Blue	Smooth
ET-012131	Red	Smooth
ET-012132	Black	Smooth
ET-012133	Grey	Smooth
ET-012134	Yellow	Smooth



Reference nr.	Colour	Type
ET-012136	Blue	Serrated
ET-012138	Red	Serrated
ET-012139	Black	Serrated
ET-012140	Grey	Serrated
ET-012141	Yellow	Serrated



EEMANN TECH TRIGGER FOR CZ 75, EXTRA FRONT-SHIFTED

Reference nr.	Colour	Type
ET-012157	Blue	Smooth
ET-012159	Red	Smooth
ET-012160	Black	Smooth
ET-012161	White	Smooth
ET-012162	Yellow	Smooth



Reference nr.	Colour	Type
ET-012164	Blue	Serrated
ET-012166	Red	Serrated
ET-012167	Black	Serrated
ET-012168	White	Serrated
ET-012169	Yellow	Serrated



Be **fast** to be first



EEMANN TECH FLAT SA/DA TRIGGER FOR CZ

Reference nr.	Colour
ET-130081	Gold
ET-130082	Silver
ET-130083	Black

Compatible with:

CZ 75
 CZ 75 SP-01
 CZ 75 SP-01 Shadow
 CZ 75 SP-01 Phantom
 CZ 75 SP-01 Shadow Line
 CZ 75 SP-01 Shadow Orange
 CZ 75 SP-01 Tactical
 CZ 75 B&BD
 CZ Shadow 2
 CZ Shadow 2 Orange

The set includes:

- Flat Trigger
- Screw for Eemann Tech Triggers for CZ (ET-131002)
- Competition Trigger Pin (ET-130064)
- Competition Trigger Spring (ET-131109)
- 1.5 mm L-Shape Hex Key (ET-030012)





EEMANN TECH ULTIMATE TRIGGER FOR CZ

Reference nr.	Color	Material
ET-130084	Black	Aluminium
ET-130085	Silver	Aluminium
ET-130086	Gold	Brass
ET-130088	Black	Steel

Compatible with:

CZ 75
 CZ 75 SP-01
 CZ 75 SP-01 Shadow
 CZ 75 SP-01 Phantom
 CZ 75 SP-01 Shadow Line
 CZ 75 SP-01 Shadow Orange
 CZ 75 SP-01 Tactical
 CZ 75 B&BD
 CZ Shadow 2
 CZ Shadow 2 Orange





EEMANN TECH COMPETITION HAMMER
FOR CZ 75, SA/DA

Reference nr.	Color
ET-130001	Black



EEMANN TECH ULTRA LIGHT HAMMER
FOR CZ 75, SA/DA

Reference nr.	Color
ET-130035	Black



EEMANN TECH ULTIMATE HAMMER FOR CZ

Reference nr.	Color
ET-130129	Black

NEW

EEMANN TECH SUPER LIGHT HAMMER FOR CZ

Reference nr.	Color
ET-130128	Black

NEW

EEMANN TECH SLIDE STOP WITH THUMB REST
FOR CZ SHADOW 2 - GREY

Reference nr.
ET-130053



EEMANN TECH REACH REDUCTION TRIGGER KIT
FOR CZ SHADOW 1/2

Reference nr.
ET-130140

NEW



EEMANN TECH COMPETITION DISCONNECTOR FOR CZ SHADOW

Reference nr.

ET-130044



The Eemann Tech Competition Disconnecter will ensure a short trigger reset without any additional modifications for your gun. It delivers the minimum pre travel at the moment of Single Action reset. Since this is a part of the trigger group - it should be legal for IPSC and USPSA Production division (Check your IPSC/USPSA rule book).

**NOT FOR PISTOLS WITH FIRING PIN BLOCKS !
ONLY FOR EXPERT SHOOTERS !**

Fits:

- CZ 75 SP-01 (without firing pin block models)
- CZ 75 SP-01 Shadow models
- CZ Shadow 2

The set includes:

- Eemann Tech Competition Disconnecter: 1 pc.
- CZ 75 Hammer Pin: 1 pc.

Material: Steel

Color: Black

CZ SHADOW 2

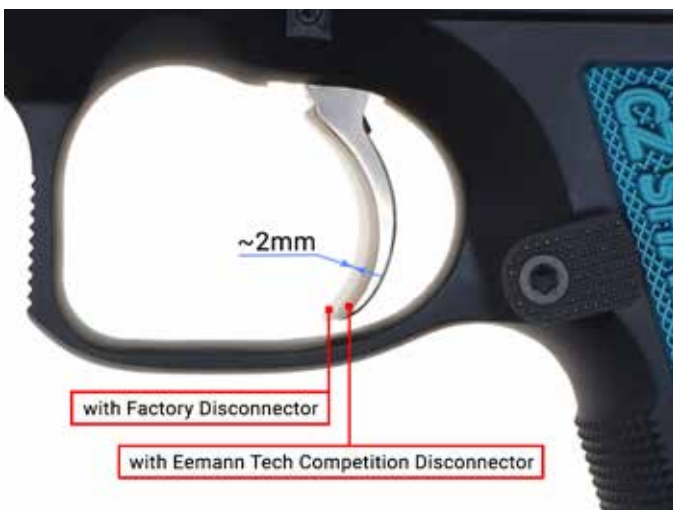

CZ 75 SP-01 SHADOW

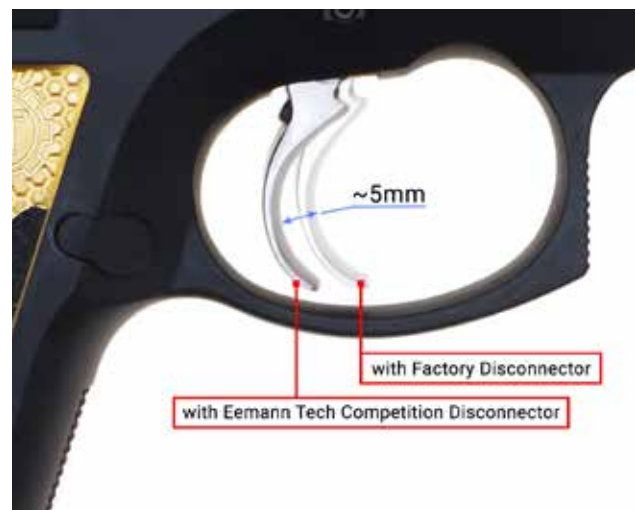



EEMANN TECH ULTIMATE DISCONNECTOR FOR CZ SHADOW

Reference nr.

ET-130124

The Eemann Tech Ultimate Disconnecter for CZ 75, CZ 75-SP01 SHADOW, CZ Shadow 2 models.

After a few years of testing and getting feedback from our customers, we have improved the Eemann Tech Competition Disconnecter and released a brand-new design!

ONLY FOR EXPERT SHOOTERS !

Fits:

- CZ 75 (with or without firing pin block models)
- CZ 75 SP-01 Shadow models (CZ Shadow 1 or similar)
- CZ Shadow 2 and their models
- CZ Shadow 2 Orange and their models

The set includes:

- Eemann Tech Ultimate Disconnecter: 1 pc.
- CZ 75 Hammer Pin: 1 pc.

Material: Steel

Color: Black

CZ SHADOW 2

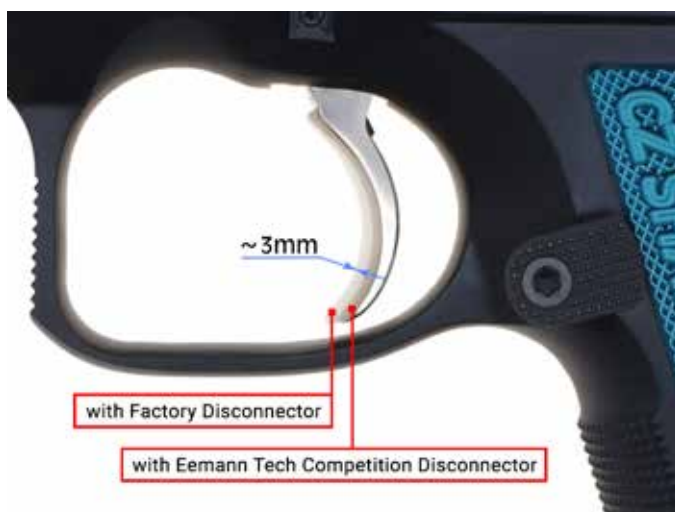

CZ 75 SP-01 SHADOW

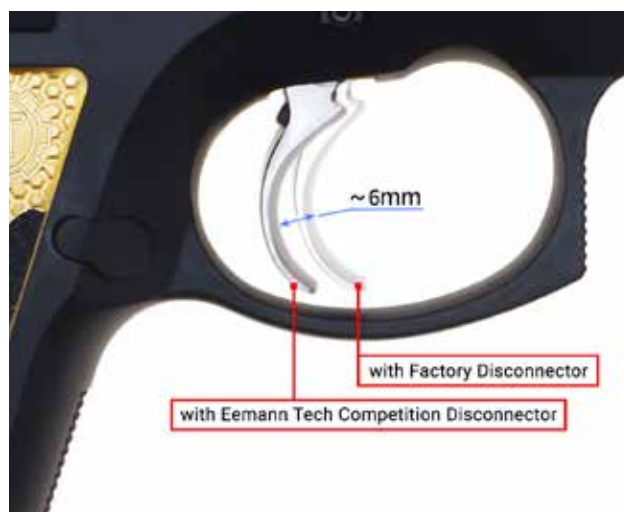



EEMANN TECH BRASS COMPETITION DISCONNECTOR FOR CZ SHADOW

Reference nr.

ET-130087

Eemann Tech Brass Competition Disconnecter for CZ 75-SP01 SHADOW, CZ Shadow 2 models.

Since this is the part of the trigger group - it should be legal for IPSC and USPSA Production division (Check your IPSC/USPSA rule book).

ONLY FOR EXPERT SHOOTERS !

Fits:

- CZ 75 SP-01 (without firing pin block models)
- CZ 75 SP-01 Shadow models
- CZ Shadow 2 models

The set includes:

- Eemann Tech Brass Competition Disconnecter: 1 pc.
- CZ 75 Hammer & Trigger Bar Pin: 1 pc. (ET-130055)

Material: Brass

CZ SHADOW 2

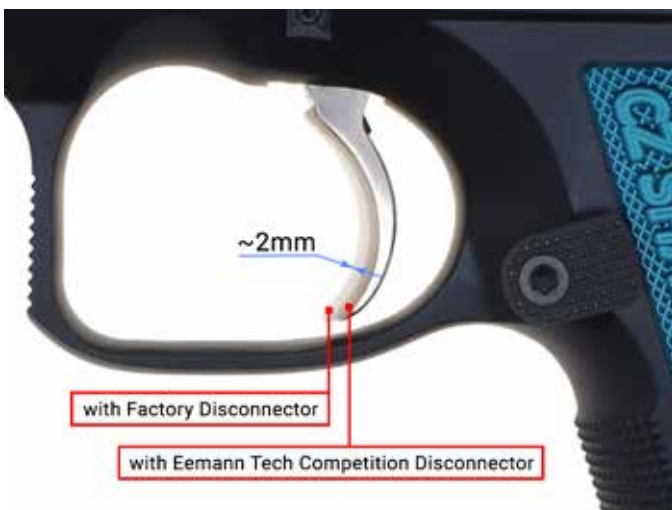

CZ 75 SP-01 SHADOW

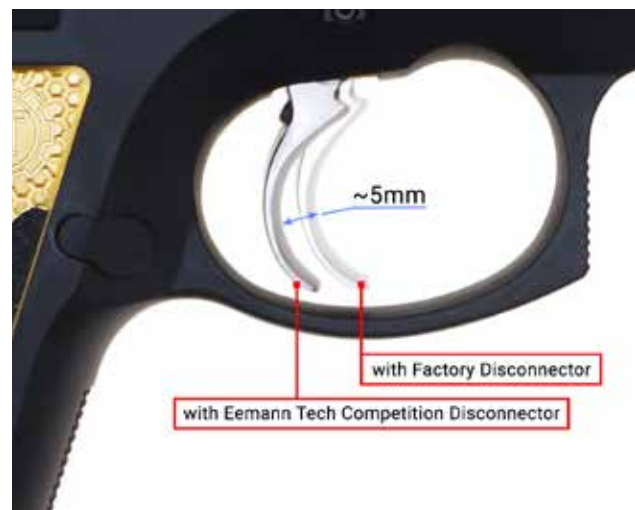



Eemann Tech Standard Base Pad for
CZ 75, CZ 75 SP-01, CZ Shadow 2



IPSC Standard box size: 225 × 150 × 45 mm

When **size** does matter



EEMANN TECH STANDARD BASE PAD FOR CZ 75,
CZ 75 SP-01, CZ SHADOW 2 - BLACK*

Reference nr.	Material
ET-130016	Aluminum

*Works with magwell



EEMANN TECH STANDARD BASE PAD FOR CZ 75,
CZ 75 SP-01, CZ SHADOW 2 - SILVER*

Reference nr.	Material
ET-130032	Aluminum

*Works with magwell



EEMANN TECH BRASS BASE PAD FOR CZ 75 TS /
TS 2*

Reference nr.	Material
ET-130079	Brass

*Works with magwell



EEMANN TECH THUMB REST SLIDE STOP FOR CZ
SHADOW 2/TS/TS2 - BLACK

Reference nr.
ET-130127

NEW



EEMANN TECH COMPETITION SLIDE STOP WITH
THUMB REST FOR CZ SHADOW 2 / CZ TS / CZ TS2

Reference nr.
ET-130078

NEW



EEMANN TECH FULL LENGTH GUIDE ROD FOR CZ 75

Reference nr.	Color
ET-130005	Black



EEMANN TECH STEEL SHORT GUIDE ROD FOR CZ 75 TS

Reference nr.	Color
ET-130007	Black



EEMANN TECH GUIDE ROD FOR CZ SHADOW 2, CZ SHADOW 2 ORANGE

Reference nr.	Color
ET-303016	Silver



EEMANN TECH GUIDE ROD FOR CZ 75 SP-01 SHADOW, NEW DESIGN

Reference nr.	Color
ET-130024	Silver



EEMANN TECH PIN FOR CZ 75

Reference nr.	Color
ET-130038	Silver



EEMANN TECH MAIN SPRING STRUT FOR CZ

Reference nr.	Color
ET-130123	Black

NEW



Eemann Tech Right Hand Safety for CZ 75 TS, CZ Shadow 2



The Eemann Tech Double-sided Extended Safety for CZ Shadow 2 and CZ 75 Tactical Sports. It also works as a support for the thumb. This type of safety improves the grip and recoil control. It has been produced in accordance with IPSC Rules for Standard Division for left and right handed shooters, and for Open Division where both levers are the same.

For the following pistols:

- CZ 75 Tactical Sports
- CZ 75 TS Orange
- CZ 75 TS Czechmate
- CZ Shadow 2



EEMANN TECH RIGHT HAND SAFETY SMALL SIZE
FOR CZ 75 TS, CZ SHADOW 2

Reference nr.	Color
ET-130012	Black



EEMANN TECH RIGHT HAND SAFETY MEDIUM
SIZE FOR CZ 75 TS, CZ SHADOW 2

Reference nr.	Color
ET-130013	Black



EEMANN TECH RIGHT HAND SAFETY LARGE SIZE
FOR CZ 75 TS, CZ SHADOW 2

Reference nr.	Color
ET-130033	Black





Eemann Tech Brass Grips for CZ 75, CZ 75 TS, CZ SHADOW 2

Made from brass that increases the weight of the pistol and improves the balance when shooting. The grips are attached with the factory screws and a spare set is provided.

Material: Brass

Set contains:

- 1 x Brass Grip Left
- 1 x Brass Grip Right
- 2 x Grip Tape Set (ET-130022)
- 2 x CZ OEM Grip Screw

Available sizes:

- Small - thickness: 0,8 mm (thinnest in the world)
- Medium - thickness: 1,8 mm
- Large - thickness: 2,8 mm
- Extra Large - thickness: 3,8 mm

Brass long grips weight:

- Small- 66 gr (1 pc) / 132 gr (2 pcs)
- Medium- 88 gr (1 pc) / 176 gr (2 pcs)
- Large- 109 gr (1 pc) / 218 gr (2 pcs)
- Extra Large- 120 gr (1 pc) / 240 gr (2 pcs)



EEMANN
TECH THE BEST PERFORMANCE



EEMANN TECH BRASS LONG GRIPS FOR CZ 75, CZ 75 TS, CZ SHADOW 2*

Reference nr.	Size	Thickness
ET-130018	Small	0,8 mm
ET-130019	Medium	1,8 mm
ET-130020	Large	2,8 mm
ET-130021	Extra Large	3,8 mm

*For using without Magwell!

EEMANN TECH BRASS SHORT GRIPS FOR CZ 75, CZ 75 TS, CZ SHADOW 2*



Reference nr.	Size	Thickness
ET-130026	Small	0,8 mm
ET-130027	Medium	1,8 mm
ET-130028	Large	2,8 mm
ET-130029	Extra Large	3,8 mm

*For using with Magwell!

EEMANN TECH ULTIMATE BRASS LONG GRIPS FOR CZ



Reference nr.	Size	
ET-130141	Small	NEW
ET-130142	Medium	NEW
ET-130143	Large	NEW
ET-130144	Extra Large	NEW

EEMANN TECH GRIP TAPE SET FOR CZ



Reference nr.	Color
ET-130022	Black

EEMANN TECH BRASS BASE PAD FOR CZ SHADOW 2



Reference nr.	Material
ET-130045	Brass

EEMANN TECH BRASS MAGWELL FOR CZ SHADOW 2



Reference nr.	Material
ET-130043	Brass



EEMANN TECH BRASS MAGWELL FOR CZ SHADOW 2

Reference nr.	Material
ET-130043	Brass

The Eemann Tech Brass Magwell (Magazine funnel) for CZ Shadow 2 will make your reloading faster, smoother and easier.

The goal of brass magwell is to increase the weight of the bottom of the gun, making it more stable during the shooting.

Material: Brass

Weight: 93g



EEMANN TECH BRASS MAGWELL FOR CZ 75
SP-01 SHADOW

Reference nr.	Material
ET-130023	Brass



EEMANN TECH COMPETITION BRASS MAGWELL
FOR CZ 75 TS/TS2

Reference nr.	Material	
ET-130119	Brass	NEW



EEMANN TECH BRASS BASE PAD FOR
CZ SHADOW 2

Reference nr.	Material
ET-130045	Brass



EEMANN TECH FIRING PIN FOR CZ 75 SP-01

Reference nr.	Color
ET-130014	Black



EEMANN TECH COMPETITION FIRING PIN FOR CZ*

Reference nr.	Color
ET-130015	Black

*The extended firing pin resolves the misfire faults caused by weak main spring.



EEMANN TECH EXTRACTOR FOR CZ SHADOW 1/2

Reference nr.
ET-130120



Born to perform

**EEMANN TECH ADJUSTABLE THUMB REST****Reference nr.**

ET-130047

**EEMANN TECH PRECISE BARREL BUSHING FOR CZ 75-01 SHADOW, CZ SHADOW 2, CZ 75 TS****Reference nr.**

ET-130034

**EEMANN TECH PRECISE BARREL BUSHING FOR CZ 85, CZ 75B, CZ 75D COMPACT****Reference nr.**

ET-130048

**EEMANN TECH PRECISE BARREL BUSHING FOR CZ 75, CZ 75BD, CZ85B****Reference nr.**

ET-130049

**EEMANN TECH THUMB REST SLIDE STOP FOR CZ 75 - BLACK****Reference nr.**

ET-130135



EEMANN TECH PINS SET FOR CZ

Reference nr.

ET-130062



EEMANN TECH TRIGGER PIN FOR CZ

Reference nr.

ET-130054



EEMANN TECH HAMMER STRUT PIN FOR CZ

Reference nr.

ET-130055



EEMANN TECH SEAR PIN FOR CZ

Reference nr.

ET-130056



EEMANN TECH MAIN SPRING PLUG PIN FOR CZ

Reference nr.

ET-130057



EEMANN TECH COMPETITION TRIGGER PIN FOR CZ

Reference nr.

ET-130064



EEMANN TECH PINS SET FOR CZ P-10

Reference nr.

ET-130115



EEMANN TECH FRONT SIGHT PIN FOR CZ

Reference nr.

ET-130058



EEMANN TECH EXTRACTOR PIN FOR CZ

Reference nr.

ET-130059



EEMANN TECH HAMMER PIN FOR CZ

Reference nr.

ET-130060



EEMANN TECH HAMMER PIN LOCK PIN FOR CZ

Reference nr.

ET-130061



EEMANN TECH PIN FOR CZ SHADOW 2 / TS / TS2

Reference nr.

ET-130110



6TX6

SMITH & WESSON

22 CALIBER USED
IN ECH





EEMANN TECH SLIDE STOP WITH THUMB REST FOR CZ 75 TACTICAL SPORT

Reference nr.	Color
ET-130065	Black
ET-130069	Grey

Advantages:

- No firearm modification required
- No fitting required and instant installation
- Provides stability and consistent grip for recoil control
- Slide stop thumb rest functions as a normal slide stop allowing slide to lock back if required
- When installed, fits in the IPSC Standard gun box
- Legal in Standard and Open divisions

Installation:

Remove existing slide stop and replace with Eemann Tech slide stop with thumb rest

Compatible:

- CZ 75 Tactical Sports
- CZ Shadow 2
- CZ 75D Compact
- CZ TS 2

Total width: 41,5 mm

Thumb rest width: 11 mm

Weight: 13 g



EEMANN TECH THUMB REST SLIDE STOP FOR CZ SHADOW 2/TS/TS2

Reference nr.	Color
ET-130127	Black

We are excited to present the Eemann Tech Thumb Rest Slide Stop for the CZ Shadow 2 / TS / TS2 pistols and their models.

Compatible with:

- CZ Shadow 2
- CZ Shadow 2 Orange
- CZ Shadow 2 Compact
- CZ 75 Tactical Sport
- CZ TS2
- CZ TS2 Race Green
- CZ TS2 Bronze

Total width: ~44 mm

Thumbrest width: ~33 mm

Material: Steel



EEMANN TECH SLIDE STOP WITH THUMB REST FOR CZ 75

Reference nr.	Color
ET-130046	Black
ET-130077	Grey

Best solution for IPSC Standard Division. Fits in IPSC Standard Box with OEM Safety.

Compatible with:

- CZ 75 B
- CZ 75 Shadow Line
- CZ 75 SP-01
- CZ 75 SP-01 Shadow

Total width: 41,5 mm
Thumbrest width: 11 mm
Material: Carbon Steel





EEMANN TECH SLIDE STOP WITH THUMB REST FOR CZ SHADOW 2 - BLACK

Reference nr.

ET-130050

Best solution for IPSC Standard Division. Fits in IPSC Standard Box with OEM Safety.

Compatible with:

- CZ Shadow 2
- CZ 75D Compact
- CZ 75 Tactical Sports
- CZ P-01



Total width: 41,5mm

Thumbrest width: 11mm

Material: Carbon Steel

Color: Black



EEMANN TECH SOLID SLIDE STOP FOR CZ 75

Reference nr.

ET-130080



EEMANN TECH SOLID SLIDE STOP FOR CZ SHADOW 2

Reference nr.

ET-130090



EEMANN TECH UPGRADE KIT FOR CZ 75 SP-01 SHADOW

Reference nr

ET-130051



EEMANN TECH UPGRADE KIT FOR CZ 75 TS

Reference nr.

ET-130063



EEMANN TECH UPGRADE KIT FOR CZ SHADOW 2

Reference nr.

ET-130052

Eemann Tech Upgrade Kit ET-130052 for CZ Shadow 2 contains:

- ET-131140 Eemann Tech Recoil Spring for CZ 10 lbs. - 1pc.
- ET-131118 Eemann Tech Main Spring for CZ 8 lbs. - 1pc.
- ET-131109 Eemann Tech Competition Trigger Spring for CZ 75 - 1pc.
- ET-131156 Eemann Tech Competition Firing Pin Spring for CZ - 1pc.
- ET-131113 Eemann Tech Competition Sear Spring for CZ 75 - 1pc.
- ET-130044 Eemann Tech Competition Disconnect for CZ - 1pc.
- ET-130015 Eemann Tech Extended Firing Pin for CZ - 1pc.
- ET-303017 Eemann Tech Competition Buffer for CZ 75 - 1pc.
- ET-130064 Eemann Tech Competition Trigger Pin for CZ - 1pc.
- ET-130055 Eemann Tech Hammer Strut Pin for CZ - 1pc.

Compatible with:

- CZ 75 SP-01 (without firing pin block models)
- CZ 75 Shadow Line
- CZ 75 SP-01 Shadow
- CZ 75 SP-01 Shadow Orange
- CZ Shadow 2
- CZ Shadow 2 Orange



Eemann Tech Aluminium Red Dot Mount for CZ Shadow / Shadow 2



EEMANN TECH ALUMINIUM RED DOT MOUNT FOR CZ SHADOW / SHADOW 2

Reference nr.	Type
ET-130901	V1
ET-130902	V2



EEMANN TECH ALUMINIUM RED DOT MOUNT FOR CZ 75/85 (NOT SHADOW MODELS)

Reference nr.	Type	
ET-130903	V1	NEW
ET-130904	V2	NEW



EEMANN TECH CZ SHADOW 2 OR PLATE MOUNT FOR VORTEX VENOM

Reference nr.

ET-130150

NEW



EEMANN TECH CZ SHADOW 2 OR PLATE MOUNT FOR C-MORE RTS

Reference nr.

ET-130151

NEW



EEMANN TECH CZ SHADOW 2 OR PLATE MOUNT FOR TRIJICON RMR

Reference nr.

ET-130152

NEW



EEMANN TECH CZ SHADOW 2 OR PLATE MOUNT FOR LEUPOLD DELTA

Reference nr.

ET-130153

NEW



EEMANN TECH CZ SHADOW 2 OR PLATE MOUNT FOR SHIELD RMS

Reference nr.

ET-130154

NEW



EEMANN TECH RED DOT MOUNT CZORV1 FOR CZ SHADOW 2 OR

Reference nr.

ET-130132



SPARE LOCATOR PIN V1C FOR EEMANN TECH RED
DOT MOUNT - 2 PCS./SET

Reference nr.

ET-130881

NEW



SPARE LOCATOR PIN V1A FOR EEMANN TECH RED
DOT MOUNT - 2 PCS./SET

Reference nr.

ET-130882

NEW



SPARE LOCATOR PIN V1E FOR EEMANN TECH RED
DOT MOUNT - 2 PCS./SET

Reference nr.

ET-130883

NEW



SPARE LOCATOR PIN V2B FOR EEMANN TECH RED
DOT MOUNT - 2 PCS./SET

Reference nr.

ET-130884

NEW



SPARE LOCATOR PIN V2D FOR EEMANN TECH RED
DOT MOUNT - 2 PCS./SET

Reference nr.

ET-130885

NEW



SPARE LOCATOR PIN V2F FOR EEMANN TECH RED
DOT MOUNT - 2 PCS./SET

Reference nr.

ET-130886

NEW





EEMANN TECH COMPETITION BUFFERS SET FOR CZ75/CZ75SP-01/CZ85

Reference nr.

ET-303013

Material:

- Polyurethane

Notes:

- Service life of the buffer is ~ 1,000 rounds
- Oils and solvents resistant

Compatible with:

- CZ 75 / 75 SP-01 / 85

Set contains:

- Competition buffer - 5 pcs.
- Package - 1 pc.
- Instruction - 1 pc.



EEMANN TECH THIN BUFFER SET FOR CZ SHADOW 2

Reference nr.

ET-303018

NEW

Material:

- Polyurethane

Notes:

- Service life of the buffer is ~ 1000 rounds (depending on the type of ammunition and springs)
- Oils and solvents resistant

Compatible with:

- CZ 75 / Shadow 1 / Shadow 2

Set contains:

- Eemann Tech Thin buffer (thickness 2mm) - 5 pcs./set

Eemann Tech Competition Recoil System for GLOCK

Reference nr.

ET-120015



Invented and produced for GLOCK17, 22, 34, 35 GEN5 models. GEN5 Recoil Spring Adapter and Installation Tool are included.



The set contains a recoil spring 13lbs. Recoil springs with other power values are available for purchasing separately (from 10lbs - 16lbs).



Recoil Spring Guide Rod is made from Carbon Steel with a maximum possible diameter for the best performance.

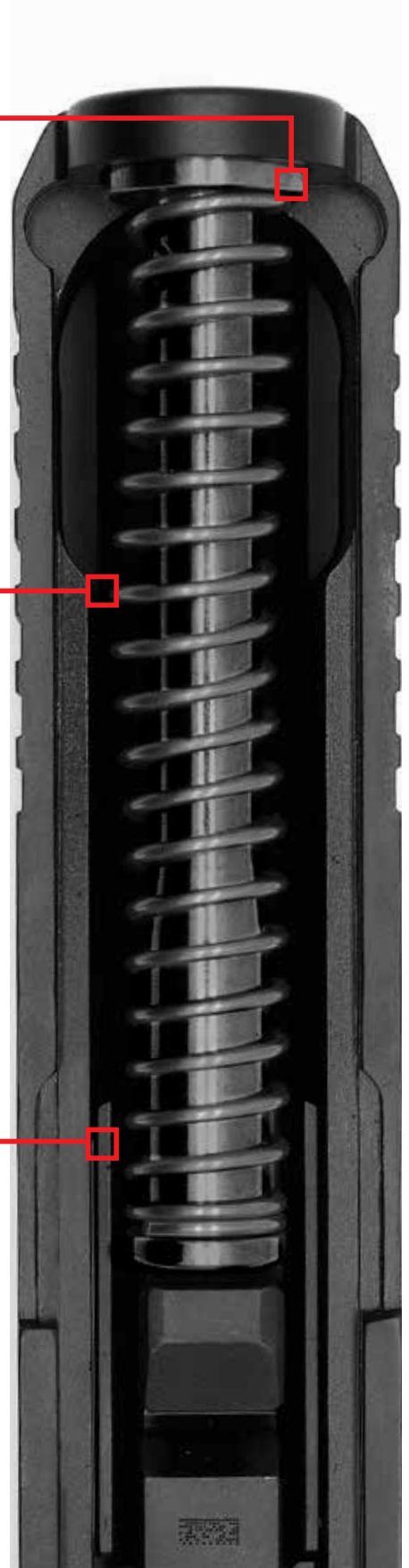

Eemann Tech Competition Recoil System for GLOCK

Reference nr.

ET-120016



Invented and produced for GLOCK19/23 GEN5. GEN5 Recoil Spring Adapter and Installation Tool are included.



The set contains a recoil spring 13lbs. Recoil springs with other power values are available for purchasing separately (from 10lbs - 16lbs).



Recoil Spring Guide Rod is made from Stainless Steel with a maximum possible diameter for the best performance.





Eemann Tech Adjustable Sights Set for GLOCK



EEMANN TECH ADJUSTABLE SIGHTS SET FOR GLOCK

Reference nr.	Diameter
ET-120027	1 mm
ET-120028	1,5 mm





EEMANN TECH COMPETITION RECOIL SYSTEM FOR GLOCK 17-22 GEN3/GEN4

Reference nr.	Color
ET-120003	Silver



EEMANN TECH COMPETITION RECOIL SYSTEM FOR GLOCK 17-22 GEN5

Reference nr.	Color
ET-120005	Silver



EEMANN TECH RECOIL SYSTEM FOR GLOCK 19-23 GEN5

Reference nr.	Color
ET-120006	Silver



EEMANN TECH COMPETITION RECOIL SYSTEM FOR GLOCK 17-22 GEN5

Reference nr.	Color	
ET-120015	Black	NEW



EEMANN TECH COMPETITION RECOIL SYSTEM FOR GLOCK 19-23 GEN5

Reference nr.	Color
ET-120016	Black



EEMANN TECH COMPETITION GRIP TAPE FOR GLOCK17 GEN5

Reference nr.
ET-120035



EEMANN TECH GRIPS 4PCS. SET FOR GLOCK
BASE PADS

Reference nr.

ET-120040



EEMANN TECH FIRING PIN FOR GLOCK 9MM

Reference nr.

ET-122001



EEMANN TECH SPACER SLEEVE FOR GLOCK

Reference nr.

ET-122002



EEMANN TECH FIRING PIN SPRING CUPS FOR
GLOCK

Reference nr.

ET-122003



EEMANN TECH COMPETITION GUIDE ROD
ADAPTER FOR GLOCK GEN4/5

Reference nr.

ET-120012

NEW



EEMANN TECH COMPETITION GUIDE ROD FOR
GLOCK 17-22 GEN5

Reference nr.

ET-120011

NEW



EEMANN TECH COMPETITION GUIDE ROD FOR
GLOCK 19-23 GEN5

Reference nr.

ET-120017



EEMANN TECH UPGRADE KIT FOR GLOCK GEN5*

Reference nr.

ET-120029

*Recommended only for OEM trigger system

The Eemann Tech Upgrade Kit for GLOCK Gen5 contains:

- ET-121003 - Eemann Tech GLOCK Firing Pin Spring (Reduced power) - This spring lightens the work of the trigger mechanism.
- ET-121020 - Eemann Tech Competition Trigger Spring for GLOCK Gen5 - This spring helps you to pull the trigger easier.
- ET-121005 - Eemann Tech GLOCK Firing Pin Safety Spring (Reduced power) - This spring lightens the work of the trigger mechanism.
- 721 - GLOCK OEM Trigger Pull Connector 4,5 lbs. (2.0 kg).
- 8794 - GLOCK OEM Magazine Catch Extended for GLOCK GEN4/5.



EEMANN TECH UPGRADE KIT FOR GLOCK GEN4*

Reference nr.

ET-120019

*Recommended only for OEM trigger system



EEMANN TECH UPGRADE KIT FOR GLOCK GEN3*

Reference nr.

ET-120020

*Recommended only for OEM trigger system



EEMANN TECH UPPER PARTS KIT FOR GLOCK 9MM GEN 1-4

Reference nr.

ET-123940

NEW



EEMANN TECH SLIDE COVER PLATE FOR GLOCK

Reference nr.

ET-122012



EEMANN TECH CHANNEL LINER FOR GLOCK

Reference nr.

ET-122004



EEMANN TECH FIRING PIN SAFETY FOR GLOCK

Reference nr.

ET-122005

EEMANN TECH EXTRACTOR FOR GLOCK 9MM
GEN 3/4

Reference nr.

ET-122030

EEMANN TECH TRIGGER HOUSING WITH EJECTOR
FOR GLOCK GEN3 9MM

Reference nr.

ET-122020

EEMANN TECH MAGAZINE CATCH EXTENDED FOR
GLOCK GEN3

Reference nr.

ET-122021

EEMANN TECH COMPETITION BUFFERS 5 PCS.
SET FOR GLOCK GEN 3

Reference nr.

ET-303012



EEMANN TECH ALUMINIUM RED DOT MOUNT FOR GLOCK

Reference nr.	Type
ET-120041	V1
ET-120042	V2

Material: Aluminium Alloy 7075 T6

Weight: 15 g

Color: Black

Type V1 ET-120041 for:

- VORTEX VENOM
- VORTEX VIPER
- BURRIS FAST FIRE
- EOTECH MRDS
- SIG ROMEO 1
- VECTOR OPTICS SCRD-35
- VECTOR OPTICS SCRD-40
- The DOCTER®sight II plus

Type V2 ET-120042 for:

- C-MORE RTS2-ST52
- BENTHLEY TSX6
- VORTEX RAZOR
- SIG SAUER ROMEO 3
- MEOPTA MEOSIGHT III
- MEOPTA MEORED
- TRIJICON RMR
- KAHLES HELIA RD 20018
- KAHLES HELIA RD 20019
- HOLOSUN HS507C
- HOLOSUN HE508T
- HOLOSUN HS407C





ROME01



EEMANN TECH SLIDE LOCK FOR GLOCK

Reference nr.

ET-122015



EEMANN TECH EXTENDED SLIDE LOCK FOR GLOCK

Reference nr.

ET-122029



EEMANN TECH TRIGGER PULL CONNECTOR FOR GLOCK

Reference nr.

ET-122016



EEMANN TECH TRIGGER HOUSING FOR GLOCK GEN3

Reference nr.

ET-122023



EEMANN TECH TRIGGER HOUSING PIN FOR GLOCK

Reference nr.

ET-122024



EEMANN TECH EXTRACTOR DEPRESSOR PLUNGER ASSEMBLY FOR GLOCK 9MM

Reference nr.

ET-122025



EEMANN TECH EXTENDED AMBI SLIDE STOP
FOR GLOCK GEN5

Reference nr.

ET-122249

NEW



EEMANN TECH TRIGGER HOUSING WITH EJECTOR
FOR GLOCK GEN4 9MM

Reference nr.

ET-122031

NEW



EEMANN TECH EXTENDED SLIDE STOP
FOR GLOCK GEN3/4

Reference nr.

ET-122032

NEW



EEMANN TECH TRIGGER WITH TRIGGER BAR
FOR GLOCK GEN4 9MM

Reference nr.

ET-122040

NEW



EEMANN TECH COMPETITION MAGWELL FOR
GLOCK 17 GEN5

Reference nr.

ET-120050

NEW



EEMANN TECH FRAME INSERT PLUG
FOR GLOCK 17 GEN 4/5

Reference nr.

ET-120051

NEW



EEMANN TECH ULTIMATE TRIGGER FOR KMR ARMS

Reference nr.

ET-134751

NEW



EEMANN TECH RED DOT MOUNT KMRORV1 FOR KMR ARMS

Reference nr.

ET-134728

NEW

- ↳ ET-134728 - 1pc.
- ↳ ET-130881 - 2pc.
- ↳ ET-130882 - 2pc.
- ↳ ET-130883 - 2pc.
- ↳ ET-130888 - 2pc.
- ↳ ET-130891 - 2pc.
- ↳ ET-130890 - 2pc.
- ↳ ET-130897 - 2pc.

Type KMRORV1 for KMR Pistols - ET-134728 for:

- **VORTEX VENOM**
- **VORTEX VIPER**
- **DOCTER**
- **SIG ROMEO 1**
- **SHIELD RMS/SMS**
- **VECTOR OPTICS SCRD-35**
- **VECTOR OPTICS SCRD-40**
- **VECTOR OPTICS SCRD-F19II**





EEMANN TECH FLAT SA/DA TRIGGER FOR TANFOGLIO

Reference nr.	Color
ET-150004	Black
ET-150005	Silver



EEMANN TECH COMPETITION BUFFERS 5 PCS. SET FOR TANFOGLIO

Reference nr.
ET-303015



EEMANN TECH ULTIMATE TRIGGER FOR TANFOGLIO

Reference nr.	Color
ET-150010	Black
ET-150011	Silver



EEMANN TECH COMPETITION DISCONNECTOR FOR TANFOGLIO

Reference nr.
ET-152010



EEMANN TECH DISCONNECTOR PIN FOR TANFOGLIO

Reference nr.
ET-150003



EEMANN TECH TITANIUM FIRING PIN FOR TANFOGLIO - LARGE FRAME

Reference nr.
ET-150001



EEMANN TECH ULTIMATE STEEL TRIGGER FOR
TANFOGLIO

Reference nr.

ET-150012



EEMANN TECH SLIDE STOP WITH THUMB REST
FOR TANFOGLIO - GREY

Reference nr.

ET-152002



EEMANN TECH SLIDE STOP WITH THUMB REST
FOR TANFOGLIO - BLACK

Reference nr.

ET-152000



EEMANN TECH ULTIMATE DISCONNECTOR
FOR TANFOGLIO

Reference nr.

ET-152030



EEMANN TECH LONG GUIDE ROD FOR TANFOGLIO

Reference nr.

ET-152012

NEW



EEMANN TECH SHORT GUIDE ROD
FOR TANFOGLIO

Reference nr.

ET-152013

NEW







EEMANN TECH BOLT CATCH PLUNGER FOR AR-15

Reference nr.

ET-180031



EEMANN TECH SAFETY DETENT FOR AR-15

Reference nr.

ET-180032



EEMANN TECH PISTOL GRIP LOCK WASHER FOR AR-15

Reference nr.

ET-180034



EEMANN TECH BUFFER RETAINER FOR AR-15

Reference nr.

ET-180035



EEMANN TECH PIVOT PIN FOR AR-15

Reference nr.

ET-180036



EEMANN TECH TAKEDOWN PIN FOR AR-15

Reference nr.

ET-180037



EEMANN TECH TAKEDOWN AND PIVOT PIN
DETENT FOR AR-15

Reference nr.

ET-180038



EEMANN TECH TRIGGER GUARD ROLL PIN
FOR AR-15

Reference nr.

ET-180039



EEMANN TECH TRIGGER AND HAMMER PIN
FOR AR-15

Reference nr.

ET-180040



EEMANN TECH GAS TUBE FOR AR-15

Reference nr.

Length

ET-180041 38,5 cm (15 1/8 inch)

ET-180042 29,9 cm (11 3/4 inch)

ET-180043 24,8 cm (9 3/4 inch)



EEMANN TECH GAS TUBE ROLL PIN FOR AR-15

Reference nr.

ET-180047



EEMANN TECH FORWARD ASSIST SPRING PIN
FOR AR-15

Reference nr.

ET-180050



EEMANN TECH EJECTOR FOR AR-15

Reference nr.

ET-180051



EEMANN TECH MAGAZINE CATCH BUTTON
FOR AR-15

Reference nr.

ET-180074



EEMANN TECH EJECTOR ROLL PIN FOR AR-15

Reference nr.

ET-180053



EEMANN TECH EXTRACTOR FOR AR-15

Reference nr.

ET-180054



EEMANN TECH EXTRACTOR PIN FOR AR-15

Reference nr.

ET-180055



EEMANN TECH EXTRACTOR SPRING INSERT
FOR AR-15

Reference nr.

ET-180057



EEMANN TECH FIRING PIN FOR AR-15

Reference nr.

ET-180059



EEMANN TECH FIRING PIN RETAINING PIN
FOR AR-15

Reference nr.

ET-180060



EEMANN TECH CAM PIN FOR AR-15

Reference nr.

ET-180061



EEMANN TECH BOLT CARRIER KEY FOR AR-15

Reference nr.

ET-180062



EEMANN TECH CHARGING HANDLE ASSEMBLY FOR AR-15

Reference nr.

ET-180064



EEMANN TECH BOLT CATCH FOR AR-15

Reference nr.

ET-180067



EEMANN TECH BOLT CATCH PIN FOR AR-15

Reference nr.

ET-180068



EEMANN TECH MAGAZINE CATCH FOR AR-15

Reference nr.

ET-180069



EEMANN TECH FORWARD ASSIST ASSEMBLY FOR AR-15

Reference nr.

ET-180049



EEMANN TECH DISCONNECTOR FOR AR-15

Reference nr.

ET-180070

EEMANN TECH BOLT GAS RING KIT FOR AR-15
- 3 PCS. SET**Reference nr.**

ET-180058



EEMANN TECH HAMMER FOR AR-15

Reference nr.

ET-180065



EEMANN TECH TRIGGER FOR AR-15

Reference nr.

ET-180072



EEMANN TECH LOCKING NUT FOR AR-15

Reference nr.

ET-180076

EEMANN TECH EXTENDED TAKEDOWN & PIVOT
PINS SET FOR AR15**Reference nr.**

ET-180100



EEMANN TECH END PLATE FOR AR-15

Reference nr.

ET-180077



EEMANN TECH EXTRACTOR FOR AR-9 PCC

Reference nr.

ET-189001



EEMANN TECH FIRING PIN FOR AR-9 PCC

Reference nr.

ET-189002

AK



EEMANN TECH EXTENDED SAFETY SELECTOR FOR AK

Reference nr.

ET-188001

NEW

PHOENIX



EEMANN TECH STEEL ULTIMATE TRIGGER FOR PHOENIX - BLACK

Reference nr.

ET-169700



EEMANN TECH ULTIMATE DISCONNECTOR FOR PHOENIX

Reference nr.

ET-169508



EEMANN TECH RECOIL SYSTEM FOR SIG SAUER P226

Reference nr.

ET-141020

Maximum available size of guide rod, possibility to change recoil spring on different power from 9 lbs - 13 lbs.

Best solution for competition and reloading ammunition.

Specification:

- Fits Sig Sauer P226
- Reduces recoil
- Quick and easy to install and remove without a gunsmith

Material: Carbon Steel, blued

Weight: 37g

Set includes:

- Steel, blued guide rod
- 13 lbs Eemann Tech Recoil Spring for Sig Sauer P226 - ET-141016

Note:

- Not legal in IPSC Production Division



EEMANN TECH COMPETITION GUIDE ROD FOR SIG SAUER P320 X5

Reference nr.

ET-145001

Maximum available size of guide rod, and possibility to change recoil spring for different power.

Best solution for competition and reloading ammunition.

Specification:

- Fits Sig Sauer P320 X5 and their models
- Adjustable recoil possibility
- Quick and easy to install and remove without a gunsmith

Material: Carbon steel, blued

Weight: 42g

Set includes:

- Steel, blackened guide rod



CZ15V1
130903



SPARE SCREWS



SPARE SCREW 3MM FOR EEMANN TECH TRIGGERS FOR CZ

Reference nr.

ET-131003



SPARE SCREW 4MM FOR EEMANN TECH TRIGGERS FOR CZ

Reference nr.

ET-131004



SPARE SCREW 5MM FOR EEMANN TECH TRIGGERS FOR CZ

Reference nr.

ET-131002



SPARE SCREW FOR EEMANN TECH STANDARD BASE PAD FOR CZ

Reference nr.

ET-130893



SPARE BLADE SCREW FOR EEMANN TECH CZ ADJUSTABLE REAR SIGHT

Reference nr.

ET-131001



SPARE SCREW FOR EEMANN TECH ADJUSTABLE REAR SIGHT FOR CZ

Reference nr.

ET-131000



EEMANN TECH GRIP SCREWS FOR CZ /
TANFOGLIO - 2 PCS./SET

Reference nr.

ET-130894



EEMANN TECH EXTENDED SCREW FOR
CZ 75 SP-01 OEM REAR FIXED SIGHT

Reference nr.

ET-012024



SPARE SCREW FOR EEMANN TECH MAGWELL
FOR CZ 75 SP-01/CZ TS/CZ TS2

Reference nr.

ET-131010

NEW



SPARE SCREW FOR EEMANN TECH MAGWELL
FOR CZ SHADOW 2

Reference nr.

ET-131008

NEW



EEMANN TECH SPARE SCREW FOR CZ OR PLATE
MOUNT - 2 PCS./SET

Reference nr.

ET-130896

NEW



EEMANN TECH SPARE SCREW
FOR CZ GRIPS - 2 PCS./SET

Reference nr.

ET-130895

NEW



EEMANN TECH GRIP SCREW HEX FOR 1911, LONG

Reference nr.	Color
ET-111240	Black
ET-112240	Silver



EEMANN TECH GRIP SCREW FLAT FOR 1911, LONG

Reference nr.	Color
ET-111241	Black
ET-112241	Silver



EEMANN TECH GRIP SCREW HEX+FLAT FOR 1911, LONG

Reference nr.	Color
ET-111242	Black
ET-112242	Silver



EEMANN TECH GRIP SCREW HEX FOR 1911, SHORT

Reference nr.	Color
ET-111243	Black
ET-112243	Silver



EEMANN TECH GRIP SCREW FLAT FOR 1911, SHORT

Reference nr.	Color
ET-111244	Black
ET-112244	Silver



EEMANN TECH GRIP SCREW HEX+FLAT FOR 1911, SHORT

Reference nr.	Color
ET-111245	Black
ET-112245	Silver



SPARE SCREW FOR EEMANN TECH MAGAZINE
CATCH WITH EXTENDED BUTTON FOR 1911/2011

Reference nr.	Color
ET-111099	Black
ET-111098	Silver



EEMANN TECH SPARE SCREW FOR 1911/2011 TWO
PIECES MAGWELL

Reference nr.	Color
ET-111186*	Black
ET-111183**	Silver

* for ET-111180

** for ET-111181



EEMANN TECH GRIP SCREW BUSHING FOR 1911

Reference nr.	Height	Color
ET-111250	4,0 mm	Black
ET-111251	4,0 mm	Silver
ET-111252	6,9 mm	Black
ET-111253	6,9 mm	Silver



SPARE SCREW FOR EEMANN TECH FIXED REAR
SIGHT FOR GLOCK

Reference nr.

ET-121002



SPARE SCREW FOR EEMANN TECH ADJUSTABLE
GLOCK REAR SIGHT

Reference nr.

ET-121001



SPARE SCREW FOR EEMANN TECH GLOCK
FRONT SIGHT

Reference nr.

ET-121000





SPARE SCREW FOR EEMANN TECH TRIGGERS
FOR KMR ARMS

Reference nr.

ET-131006

NEW



EEMANN TECH SPARE SCREW FOR KMR OR PLATE
MOUNT - 2 PCS./SET

Reference nr.

ET-130897





EEMANN TECH PISTOL GRIP SCREW FOR AR-15

Reference nr.

ET-180033



EEMANN TECH BOLT CARRIER KEY SCREW FOR AR-15

Reference nr.

ET-180063





EEMANN TECH SPARE SCREW T15 FOR RED DOT MOUNT V1 - 2 PCS./SET

Reference nr.

ET-130891



ADJUSTMENT SET SCREW FOR EEMANN TECH RED DOT MOUNT - 2 PCS./SET

Reference nr.

ET-130889



EEMANN TECH SPARE SCREW AND LOCK WASHER FOR VORTEX VENOM - 2 PCS./SET

Reference nr.

ET-130888

NEW



EEMANN TECH SPARE SCREW M4X10 FOR RED DOT MOUNT V2- 2 PCS./SET

Reference nr.

ET-130890

NEW



EEMANN TECH SPARE SCREW M4X12 FOR RED DOT MOUNT V2- 2 PCS./SET

Reference nr.

ET-130892

NEW



HEX SOCKET SET SLIDE LOCK SCREW FOR EEMANN TECH RED DOT MOUNT V1 - 2 PCS./SET

Reference nr.

ET-130880

NEW



HEX SOCKET SLIDE LOCK SCREW FOR EEMANN TECH RED DOT MOUNT V2 - 2 PCS./SET

Reference nr.

ET-130887

NEW

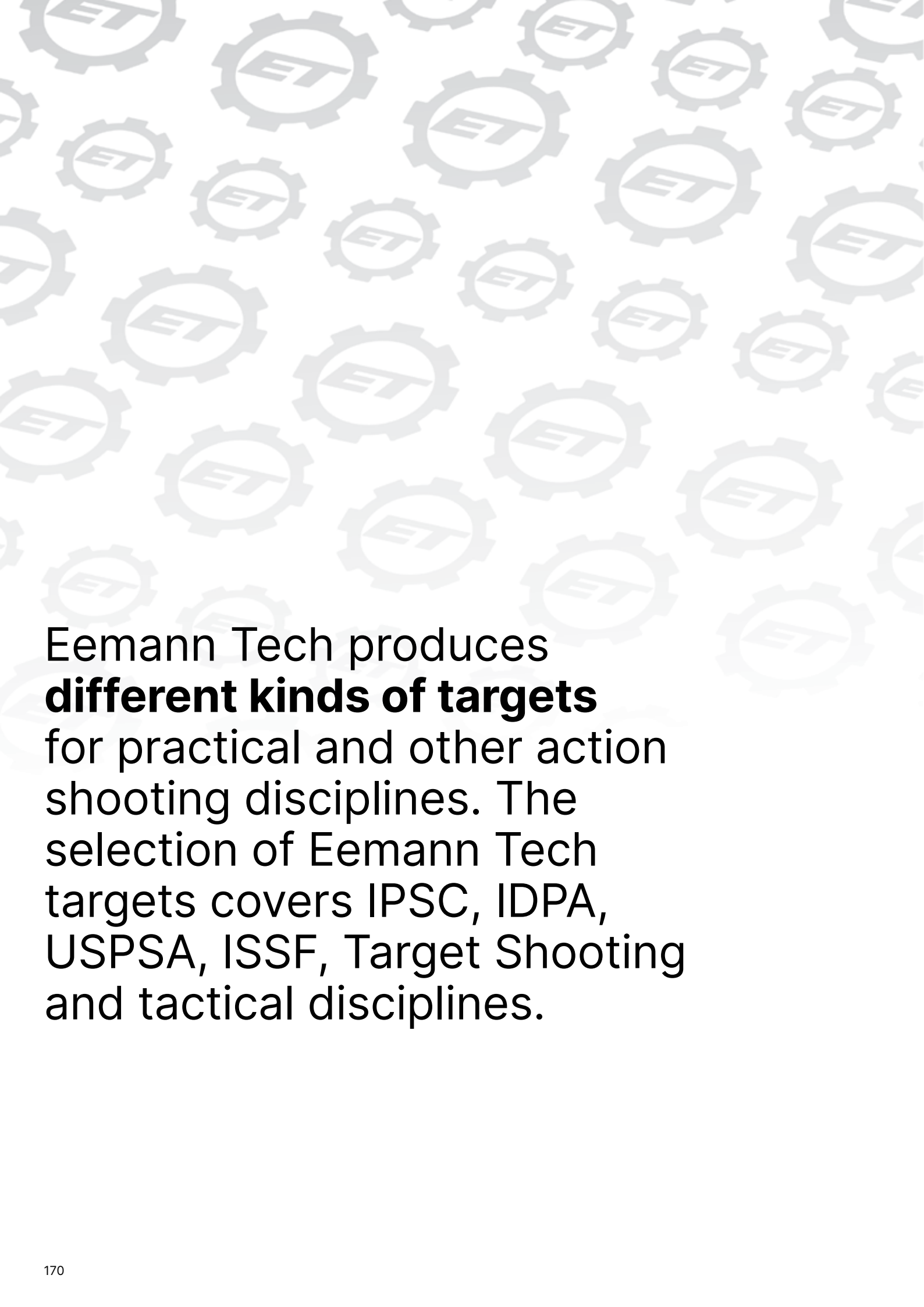

Eemann Tech produces **different kinds of targets** for practical and other action shooting disciplines. The selection of Eemann Tech targets covers IPSC, IDPA, USPSA, ISSF, Target Shooting and tactical disciplines.



Cardboard targets are the “expendable material” for any kind of competition from Level I to World Shoots, Club team practices, individual training, and master classes. You can never have enough targets! Eemann Tech Company produces cardboard and paper targets for indoor shooting galleries and open-air shooting ranges.

In addition to the target selection Eemann Tech offers different types of target patches.

Our patches are made of water- and frost-resistant material. Specially designed for the IPSC/IDPA and their type of targets. The 20 mm patches are meant for patching hits from handgun, rifle shots or shotgun buckshots. The 30 mm patches are meant for rifle shots starting from caliber 7.62 mm. The 40 mm patches are meant for patching hits from shotgun slugs. The range of Eemann Tech patches have a wide selection of colors, diameter and quantity per roll.

Besides the paper and cardboarded targets Eemann Tech has a selection of Self Setting Metal Plate Targets. The Self Setting Targets are made of HARDOX steel and are intended for competition and shooting practice with handgun or rifle.

All products manufactured by Eemann Tech are labelled and have original packaging.

TARGETS & PATCHES



Eemann Tech Self Setting Steel
Target, HARDOX, 200 mm



Taking **training** to the next level

THE EEMANN TECH SELF SETTING STEEL TARGET, HARDOX, 200 MM

Reference nr.

ET-040012

Technical Specifications

- Plate material: HARDOX 450 (plate)
- Plate thickness: 12 mm
- Plate diameter: 20 cm
- Height: 28 cm
- Weight: 9 kg

Set Contains

- Eemann Tech IPSC Self Setting HARDOX Steel Target
- 2-springs-set [ET-040010]
- Additional 2-springs-set with reduced power -10% [ET-040011]

Target Has Been Tested By

- Pistol at 7 meters distance (calibers: 9×19; 7,62×25; .38 SUPER)
- Rifle at 100 meters distance (calibers: .223 REM; 7,62×39; .308 WIN; 7,62×54R)



Steel Targets

The Eemann Tech IPSC Self Setting HARDOX Steel Target made of HARDOX steel for competition and practice shooting using handgun or rifle.

The plate rises by means of special springs that can be easily removed if needed. The speed and rigidity of rising the plate backwards depends on springs power.

To maximize the training effect and have the plate rise back again to the standing position after each shot the plate should be used as it was designed with springs set mounted. To satisfy shooters with different firearm power factor the self setting plate set contains different power springs to provide the option for customization, to meet your needs and expectations. Using the Eemann Tech Self Setting Steel Target will take training to the next level!

To use the plate for IPSC competitions the springs can be easily removed and the plate will work as a normal falling plate.

The self setting plate has a heavy base made of steel that keeps the plate in place whilst shooting. To fix the plate in place reliably the special holes are perforated on the horizontal parts of the plate base. Using the securing holes, the plate can be either fixed on the ground in the vertical position or secured to some stable construction downwards.



SELF SETTING STEEL TARGET, HARDOX, 200 MM

Reference nr.

ET-040012



SPARE PLATE FOR SELF SETTING STEEL TARGET
200 MM X 12 MM, HARDOX

Reference nr.

ET-040013



SPARE ASSEMBLY KIT FOR SELF SETTING STEEL
TARGET

Reference nr.

ET-040014



SPARE SPRING SET FOR SELF SETTING STEEL
TARGET

Reference nr.

ET-040010



SPARE SPRING SET FOR SELF SETTING STEEL
TARGET, REDUCED POWER -10%

Reference nr.

ET-040011



EEMANN TECH SPARE LYNCH PINS SET
FOR SELF SETTING TARGET

Reference nr.

ET-040016

EEMANN TECH IPSC MINI POPPER

Reference nr.

ET-040020

Technical Specifications

- Popper material: Steel S355
- Mounting base material: Steel S355
- Popper thickness: 10 mm
- Popper diameter: 200 mm
- Height: 55 cm
- Nett Weight: 11.9 kg
- Gross Weight: 12.5 kg

Set Contains

- 1 x Eemann Tech IPSC Mini Steel Popper
- 1 x Adjusting Bolt
- 1 x IPSC Mini Popper Assembly Kit ET-040014



Mini Popper

The Eemann Tech IPSC Mini Popper is made of steel and designed to be stable when using it on a hard surface, on the ground, or in indoor shooting ranges. It can be used for IPSC, USPSA and IDPA for both handgun and shotgun competitions and training. Not recommended for rifle.

The IPSC Mini Popper has a heavy mounting base made of steel that keeps the popper in place while shooting.

The popper can be secured to a stable structure or to the floor using the securing holes provided in the frame if required.





Eemann Tech Cardboard IPSC
Target, TAN/WHITE, 100pcs

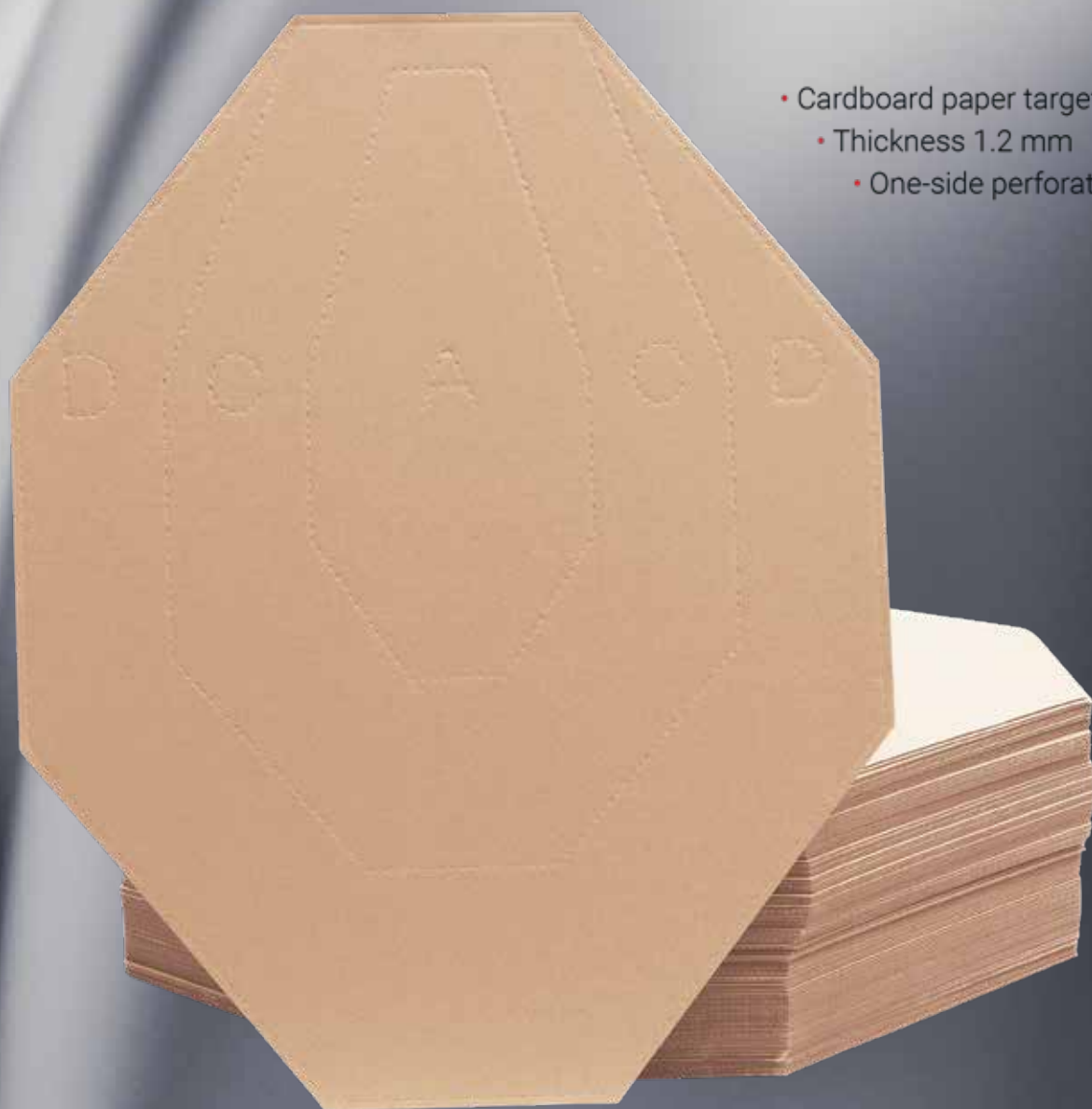

- Cardboard paper targets
- Thickness 1.2 mm
- One-side perforated

Train your shooting **accuracy**
to be perfect



CARDBOARD IPSC TARGET

Reference nr.	Color	Quantity
ET-202100	TAN / WHITE	100 pcs

*Target's size is original size from IPSC rulebook (Appendix B2)



CARDBOARD IPSC MINI TARGET

Reference nr.	Color	Quantity
ET-213100	TAN / WHITE	100 pcs

*Target's size is 60% from Cardboard IPSC Target ET-202100



CARDBOARD IPSC MICRO TARGET

Reference nr.	Color	Quantity
ET-223100	TAN / WHITE	100 pcs

*Target's size is 40% from Cardboard IPSC Target ET-202100

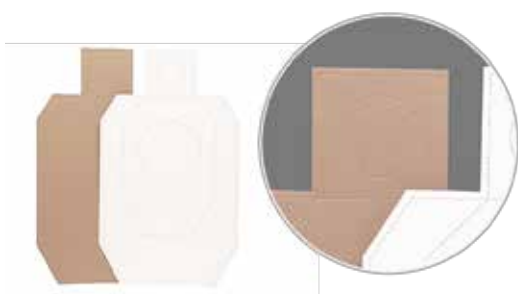

CARDBOARD IDPA TARGET

Reference nr.	Color	Quantity
ET-231100	TAN / WHITE	100 pcs

High quality IPSC legal targets for competition and training needs.

Perforated to include A, C, and D zones.

Perforation on Tan/White targets is done on the front side of target (Tan side). White side can be used both as Penalty Target and Scoring Target (perforation of scoring lines on white side is visible).

Material: Cardboard

Available quantity per pack: 100 pcs.

Color: Tan/White

Packaging: Transparent Stretch Wrap



CARDBOARD METRIC TARGET

Reference nr.	Color	Quantity
ET-239100	TAN / WHITE	100 pcs



CARDBOARD ALTERNATIVE IDPA TARGET

Reference nr.	Color	Quantity
ET-232100	TAN / WHITE	100 pcs



CARDBOARD TACTICAL TARGET

Reference nr.	Color	Quantity
ET-224100	TAN / WHITE	100 pcs



CARDBOARD IPSC PAINTED TARGET

Reference nr.	Color	Quantity
ET-202950	TAN / WHITE	50 pcs



WATERPROOF IPSC TARGET

Reference nr.	Color	Quantity
ET-203050	TAN / WHITE	50 pcs



IPSC VERTICAL PAINTED TARGET

Reference nr.	Color	Quantity
ET-202350	TAN+BLACK/WHITE	50 pcs



Eemann Tech Paper Target
Patches Roll



Giving a second **life** to targets



EEMANN TECH PAPER TARGET PATCH ROLL TAN

Reference nr.	Diameter	Quantity per roll
ET-302023	14 mm	1000 pcs
ET-302001	20 mm	1000 pcs
ET-302002	20 mm	2000 pcs
ET-302014	20 mm	3000 pcs
ET-302003	30 mm	1000 pcs
ET-302004	40 mm	1000 pcs



EEMANN TECH PAPER TARGET PATCH ROLL WHITE

Reference nr.	Diameter	Quantity per roll
ET-302024	14 mm	1000 pcs
ET-302005	20 mm	1000 pcs
ET-302017	20 mm	2000 pcs
ET-302006	30 mm	1000 pcs
ET-302007	40 mm	1000 pcs



EEMANN TECH PAPER TARGET PATCH ROLL BLACK

Reference nr.	Diameter	Quantity per roll
ET-302025	14 mm	1000 pcs
ET-302008	20 mm	1000 pcs
ET-302018	20 mm	2000 pcs
ET-302009	30 mm	1000 pcs
ET-302010	40 mm	1000 pcs



EEMANN TECH PAPER TARGET PATCH ROLL GREEN

Reference nr.	Diameter	Quantity per roll
ET-302026	14 mm	1000 pcs
ET-302011	20 mm	1000 pcs
ET-302019	20 mm	2000 pcs
ET-302012	30 mm	1000 pcs
ET-302013	40 mm	1000 pcs



EEMANN TECH PAPER TARGET PATCH ROLL RED

Reference nr.	Diameter	Quantity per roll
ET-302015	20 mm	1000 pcs
ET-302016	40 mm	1000 pcs

EEMANN TECH TARGET PATCHES ORGANIZER



Reference nr.	Color	
ET-302021	Black	NEW
ET-302022	Red	NEW



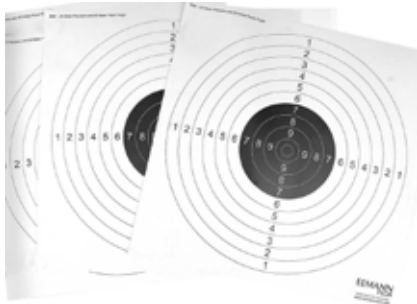

THE EEMANN TECH ISSF 25M TARGET 550 MM X 550 MM

Reference nr.

ET-222100

Eemann Tech ISSF 25M Precision & 50M Pistol Target for:

- 50 m Pistol
- 25 m Standard Pistol events
- 25 m Center Fire precision stage
- 25 m Pistol events

Available quantity per pack: 100pcs.

Inner ten: 25 mm (± 0.2 mm)

Black from 7 to 10 rings = 200 mm (± 1.0 mm)

Ring thickness: 0.2 mm to 0.5 mm

Size: 550 mm x 550 mm

ISSF - 25 Meter Precision and 50 Meter Pistol Target

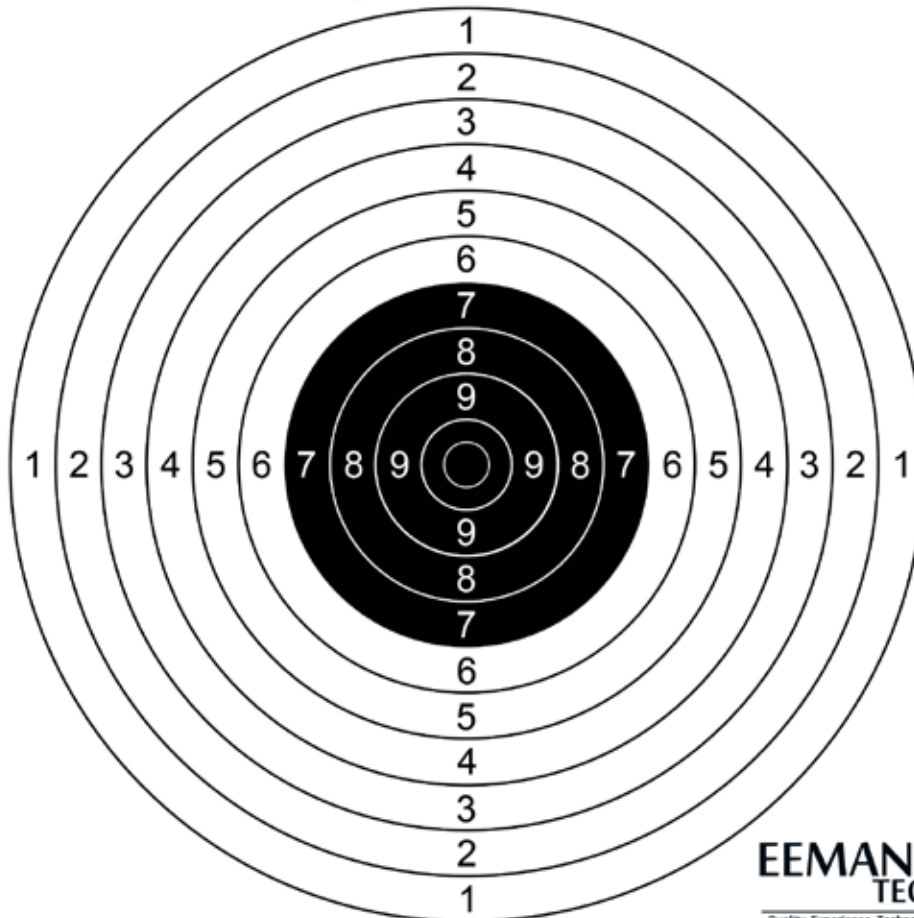

**EEMANN
TECH**
Quality. Experience. Technology.
www.eemann-tech.com

Practice makes perfect



EEMANN TECH IPSC DRY FIRING TRAINING KIT

Reference nr.

ET-222101



EEMANN TECH USPSA DRY FIRING TRAINING KIT

Reference nr.

ET-222102



EEMANN TECH IDPA DRY FIRING TRAINING KIT

Reference nr.

ET-222103



The Eemann Tech Dry Firing Targets Kit is specially made for home dry fire training exercises. The targets are laser cut products made of 2 mm thick MDF and have A, C and D zones clearly marked.

Each target has a hole on the top part for attaching purposes onto any soft surfaces by tacs (included). The holes located on the target's sides are meant for rotation imitation. Cut targets represent hard cover targets.

The Targets Have 3 Sizes

- Large targets: 15 cm tall that are 26 % of full-size target and imitate medium distance
- Medium targets: 9 cm tall that are 16 % of full-size target and imitate long distance
- Small targets: 6 cm tall that are 10 % of full-size target and imitate very long distance

Color

- Targets are of TAN color
- Poppers are of WHITE color





TOOLS & CLEANING



EEMANN TECH GUN BORE ROPE CLEANER

Reference nr.	Caliber
ET-030023	9×19 mm
ET-030024	.223 Rem
ET-030025	.308 Win
ET-030026	.40 S&W
ET-030027	12 Gauge
ET-030028	.45AUTO
ET-030029	.22LR
ET-030031	.177 (4.5 mm)



EEMANN TECH TORX KEY T15 L-SHAPED

Reference nr.
ET-030011



EEMANN TECH TORX KEY T20 L-SHAPED

Reference nr.
ET-030010



EEMANN TECH HEX KEY 1,5MM L-SHAPED

Reference nr.
ET-030012



EEMANN TECH HEX KEY 2MM L-SHAPED

Reference nr.
ET-030013



EEMANN TECH HEX KEY 2,5MM L-SHAPED

Reference nr.
ET-030014



EEMANN TECH HEX KEY 3MM L-SHAPED

Reference nr.

ET-030015

NEW



EEMANN TECH HSS DRILL FOR THE CZ FRONT SIGHT

Reference nr.

ET-020002



EEMANN TECH DIAMOND FILES 10-PCS SET

Reference nr.

ET-030009



EEMANN TECH IPSC SCORING HANDGUN OVERLAY

Reference nr.

ET-030030



EEMANN TECH PISTOL AMMO CHAMBER CHECKER

Reference nr.

Caliber

ET-030020

9×19 mm

ET-030021

.40 S&W

ET-030022

.45AUTO

.45auto .40S&W 9×19 mm



EEMANN TECH 4-PCS PLASTIC HOOK SET

Reference nr.

ET-030100



EEMANN TECH GRIP TAPE 5 CM X 30 CM

Reference nr.	Pistol model
ET-303001	Black
ET-303002	Blue
ET-303003	Green
ET-303004	Yellow
ET-303005	Red
ET-303007	Grey
ET-303009	Camouflage



EEMANN TECH REPLACEMENT FIBER ROD - 2PCS./SET

Reference nr.	Color	Diameter	
ET-031010	Red	1 mm	NEW
ET-032010	Green	1 mm	NEW
ET-033010	Yellow	1 mm	NEW
ET-031015	Red	1,5 mm	NEW
ET-032015	Green	1,5 mm	NEW
ET-033015	Yellow	1,5 mm	NEW
ET-031020	Red	2 mm	NEW
ET-032020	Green	2 mm	NEW
ET-033020	Yellow	2 mm	NEW



EEMANN TECH HANDGRIP 90 ML

Reference nr.
ET-030040



EEMANN TECH BRASS SQUIB ROD

Reference nr.	
ET-030039	NEW



EEMANN TECH INSTALLATION TOOL FOR ET GUIDE RODS

Reference nr.	
ET-120010	NEW



EEMANN TECH SLIDE LOCK TOOL FOR CZ

Reference nr.

ET-030332



EEMANN TECH SLIDE LOCK TOOL FOR 1911/2011

Reference nr.

ET-030333



EEMANN TECH SLIDE LOCK TOOL FOR GLOCK

Reference nr.

ET-030334

EEMANN TECH SLIDE LOCK TOOL FOR
SIG SAUER P320

Reference nr.

ET-030335



EEMANN TECH SLIDE LOCK TOOL FOR CZ P-10

Reference nr.

ET-030336

NEW

EEMANN TECH SLIDE LOCK TOOL FOR
TANFOGLIO

Reference nr.

ET-030337

NEW

EEMANN TECH SLIDE LOCK TOOL FOR WALTHER
PPQ/PDP

Reference nr.

ET-030338

NEW



EEMANN TECH SLIDE LOCK TOOL
FOR BERETTA 92/92X

Reference nr.

ET-030339

NEW



EEMANN TECH SEAR SPRING INSTALLATION
TOOL FOR TANFOGLIO

Reference nr.

ET-150007

NEW

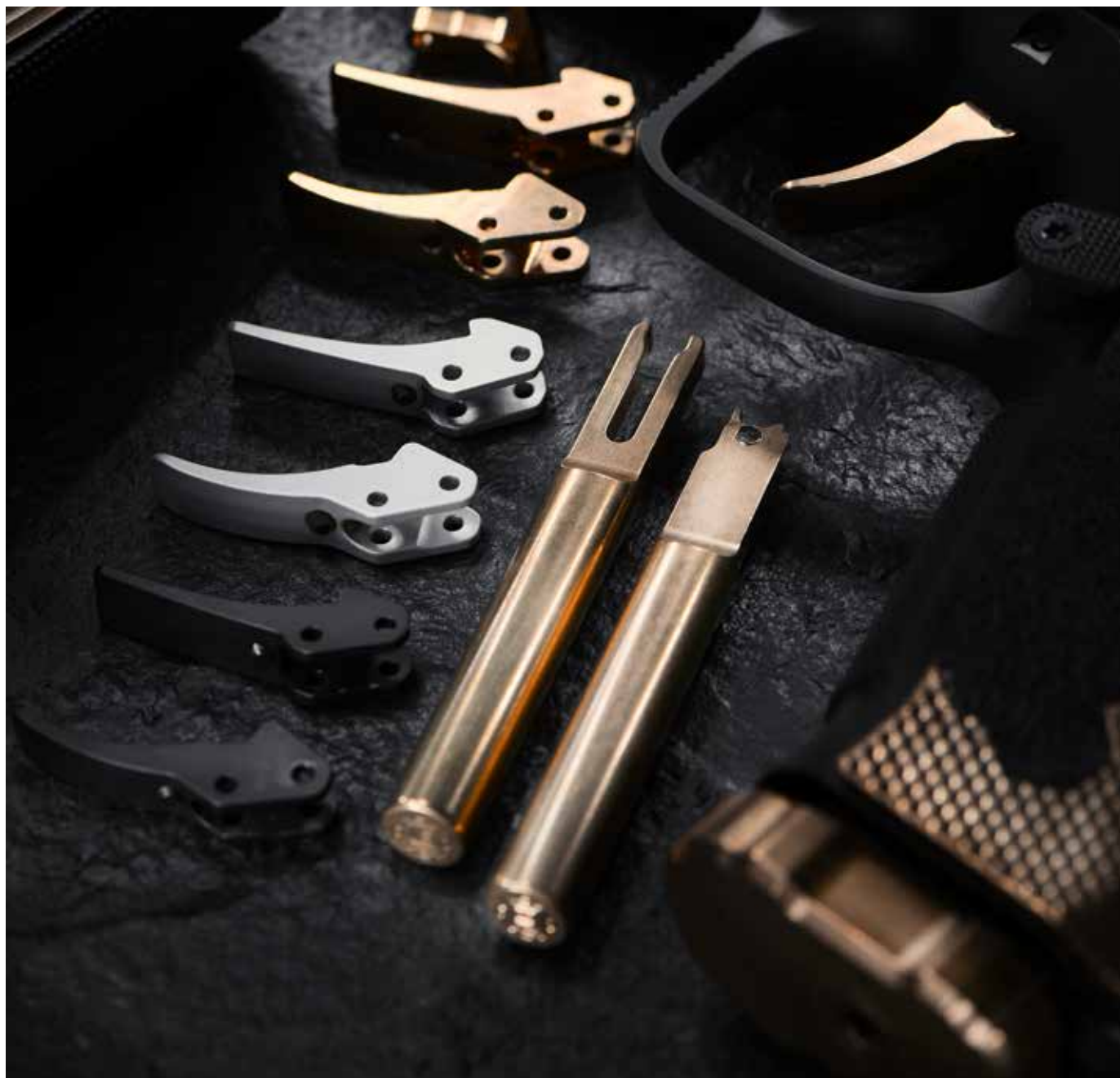



EEMANN TECH SEAR SPRING INSTALLATION TOOL FOR CZ

Reference nr.

ET-130067



EEMANN TECH DOVETAIL FRONT SIGHT INSTALLATION TOOL

Reference nr.

ET-111002





EEMANN TECH CORN COB POLISHING MEDIA
M16 - 2 KG

Reference nr.

ET-030032

High quality corn cob media which can remove grit, dirt and powder residue from your cases.

The media can be used repeatedly but should be replaced periodically for the best result. The small grain media is perfect for use in small to medium size tumblers and cleans even the smallest recesses of case rims and primer pockets.

Works great with all polishing additives. Just a few spoons onto the media and then a few hours in your tumbler – and your brass will come out looking like new!



EEMANN TECH STAR CHAMBER CLEANING PADS
FOR AR-15 - 50PCS./PACK

Reference nr.

ET-030042

NEW



EEMANN TECH STAR CHAMBER CLEANING PADS
FOR AR-15 - 10PCS./PACK

Reference nr.

ET-030041

NEW

When cleaning the chamber of your modern sporting AR15, normal patches are simply not made for this job.

The Eemann Tech Chamber Cleaning Pads for AR15 are precision cut to easily fit into your bolt chamber.

They are specially designed for easier and faster removal of loosened carbon and help to evenly distribute solvents and lubricants.

Compatible with most standard cleaning rods.

Includes 10 wool chamber pads per pack.





FILIPINAS ASIA S

ONE EVO
G
G
G
G



EEMANN
TECH
www.eemann-tech.com

Quality.
Experience.
Technology.





APPARELS & ACCESSORIES



DED SPORTSWEAR SET EEMANN TECH COMPETITION SPRINGS THEME

Reference nr.	Size
ET-430106	2 XS
ET-430107	XS
ET-430108	S
ET-430109	M
ET-430110	L
ET-430111	XL
ET-430112	2 XL
ET-430113	3 XL
ET-430114	4 XL
ET-430115	5 XL
ET-430116	6 XL
ET-430117	7 XL
ET-430118	8 XL
ET-430119	9 XL
ET-430120	10 XL

Fabric:

LITE-X



EEMANN TECH CASUAL T-SHIRT - RED

Reference nr.	Size	Type
ET-405306	2 XS	Regular
ET-405292	XS	Regular
ET-405293	S	Regular
ET-405294	M	Regular
ET-405295	L	Regular
ET-405296	XL	Regular
ET-405297	2 XL	Regular
ET-405298	3 XL	Regular
ET-405305	4 XL	Regular
ET-405304	5 XL	Regular
ET-405303	6 XL	Regular
ET-405302	7 XL	Regular
ET-405301	8 XL	Regular
ET-405300	9 XL	Regular
ET-405299	10 XL	Regular
ET-405282	2 XS	Women
ET-405283	XS	Women
ET-405284	S	Women
ET-405285	M	Women
ET-405286	L	Women
ET-405287	XL	Women
ET-405288	2 XL	Women
ET-405289	3 XL	Women
ET-405291	4 XL	Women
ET-405290	5 XL	Women
ET-405275	XS	Kids
ET-405276	S	Kids
ET-405277	M	Kids
ET-405278	L	Kids
ET-405279	XL	Kids
ET-405280	2 XL	Kids
ET-405281	3 XL	Kids

Fabric:

LITE-X



DED EEMANN TECH COMPETITION SPRINGS LANYARD

Reference nr.

ET-420218



EEMANN TECH RUBBER MAT RED

Reference nr.

ET-009023

Size

900×400 mm



EEMANN TECH PEN

Reference nr.

ET-009029

NEW



EEMANN TECH NOTEBOOK

Reference nr.

ET-009021

Size

A5



EEMANN TECH STEEL MUG 210ML

Reference nr.

ET-009050



EEMANN TECH GEAR LAPEL PIN 2CM

Reference nr.

ET-009019

NEW



EEMANN TECH CAP - GREY

Reference nr.

ET-009060



EEMANN TECH SNAPBACK CAP - DARK GREY

Reference nr.

ET-009061

NEW



EEMANN TECH UMBRELLA WHITE

Reference nr.

ET-009070



EEMANN TECH CLEANING CLOTH

Reference nr.

ET-030045



EEMANN TECH CALENDAR 2024

Reference nr.

ET-009042

NEW

Stay in contact with us:

Härgmäe 24, Tallinn
13525 Estonia

export@eemann.tech
www.eemann.tech



facebook.com/eemanntechofficial
instagram.com/eemanntech
youtube.com/eemanntech

