



CATALOGUE 2026



ABOUT US

4-5

SPRINGS

CZ	8-25
1911/2011	26-36
TANFOGLIO	37-41
GLOCK	42-49
SIG SAUER	50-53
BERETTA	54-59
AR-15	60-65
AR-9 PCC	65-65
MOLOT-VEPR 12GA	66-66
BENELLI	67-67
GRAND POWER	68-73
DILLON PRECISION	74-82
PHOENIX	83-87
WALTHER	88-89
KMR	90-93
MAGLULA	95-95
SPS	95-95
ARMA ZEKA	95-95
JP5 PCC	95-95
MARK7 APEX10	95-95

PARTS

1911/2011	98-127
CZ	128-202
GLOCK	203-227
KMR	228-231
TANFOGLIO	232-237
BERETTA	238-239
PHOENIX	240-244
WALTHER	245-247
AR-15	248-254
AR-9 PCC	255-255
ADC PCC	255-255
AK	256-256
GRAND POWER	256-256
JP PCC	256-256
SIG SAUER	258-259

SPARE SCREWS

CZ	261-262
1911/2011	263-265
GLOCK	266-266
KMR	267-267
AR-15	268-268
JP PCC	268-268
RED DOT MOUNTS	270-271



VR TRAINING	272-277
<hr/>	
TARGETS & PATCHES	
STEEL TARGETS	282-283
IPSC MINI POPPER	284-284
CARDBOARD TARGETS	286-289
TARGET PATCHES	290-291
PATCHES ORGANIZER	292-292
ISSF 25M TARGET	293-293
DRY FIRING KITS	294-294
<hr/>	
TOOLS & CLEANING	
TOOLS	296-309
CLEANING ACCESSORIES	310-310
<hr/>	
RAIN HARD COVERS	312-314
<hr/>	
SHOTGUN ACCESSORIES	315-317
<hr/>	
APPARELS & ACCESSORIES	
APPARELS	319-325
<hr/>	
FIREARM STANDS	326-329
<hr/>	
NOTES	330-333

CONTENTS

EEMANN TECH is a distinguished leader in the world of shooting sports and firearm accessories.

With a legacy rooted in precision engineering and a commitment to excellence, we have earned a renowned reputation within the industry.

Our company was founded by a team of seasoned experts, each possessing extensive experience and knowledge in the realm of IPSC (International Practical Shooting Confederation), USPSA (United States Practical Shooting Association), and shooting sports competitors. Their deep understanding of the sport, gained through active participation at the highest levels of international competitions and organizational roles in IPSC and USPSA matches, sets us apart as a trusted authority.

At EEMANN TECH, our primary focus is on manufacturing and delivering high-quality spare and tuning parts, as well as a comprehensive range of accessories designed specifically for shooting sports enthusiasts. We're proud of the quality and innovation that goes into every product, making sure they meet the high standards of the shooting sports community.

Our dedication to excellence extends beyond our products. We are committed to providing outstanding customer support, technical expertise, and a seamless shopping experience for our customers worldwide. With a commitment to quality, performance, and safety, EEMANN TECH continues to be the preferred choice for shooting sports enthusiasts and professionals alike.



Our mission

As a global mission, we are driven by enthusiasm to deliver top-quality products and professional services to customers worldwide, setting high performance standards for ourselves. We combine our passion, excellence, and commitment with advanced technology and expertise to ensure precision and top-notch quality everywhere we do.



Our goal

Our primary goal is to help competitors achieve their best results and support them in reaching international success on their path to excellence.

Cooperation

We operate on a B2B dealer contract basis with gun shops worldwide. We do not engage in retail sales; our focus is strictly on B2B transactions.

EEMANN TECH's dealership cooperation is non-exclusive. We offer equal opportunities to all interested dealers to excel in the market. Any gun shop can express their interest in becoming an EEMANN TECH dealer and offer a wide selection of EEMANN TECH products in their stores to meet the needs of their customers.

If you are interested in collaboration and wish to become an EEMANN TECH dealer, please complete the Contact form to send your inquiries or requests to us on our website.

As a dealer, you will gain access to our extensive EEMANN TECH product line, as well as products from other brands we distribute. You will be among the first to receive updates, and your company will be prominently featured as an official dealer on our website and other social media channels. We are always open for cooperation and ready to answer any questions you have!



We offer a wide selection of tuning and factory-power springs for the most popular pistol models used in IPSC and USPSA shooting sports

including 1911/2011, CZ, Glock, Tanfoglio, Sig Sauer, Beretta, Benelli, Grand Power, Phoenix, AR-15/AR-9 PCC, and many others.



SPRINGS

Competitors can personalize their shooting gear with EEMANN TECH parts to meet their specific needs according to the division rules. We have all the necessary components for your handguns to match factory settings or customize them extensively with EEMANN TECH tuning springs and parts.

Thanks to advanced technology, our springs have an extended service life.

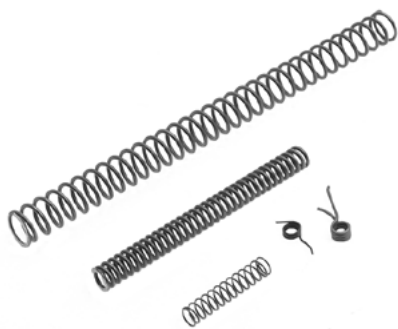

EEMANN TECH COMPETITION SPRINGS KIT FOR CZ

Reference nr.

ET-131203

- ↳ ET-131141 - 1pc.
- ↳ ET-131119 - 1pc.
- ↳ ET-131109 - 1pc.
- ↳ ET-131156 - 1pc.
- ↳ ET-131113 - 1pc.

Compatible with:

- CZ 75, CZ 75B
- CZ 85, CZ 85B
- CZ 75 SP-01, CZ 75 SP-01 Tactical
- CZ 75 SP-01 Shadow, CZ 75 SP-01 Shadow Orange
- CZ Shadow 2, CZ Shadow 2 Orange



EEMANN TECH COMPETITION SPRINGS KIT FOR CZ 75 TACTICAL SPORT

Reference nr.

ET-131204

- ↳ ET-131141 - 1pc.
- ↳ ET-131119 - 1pc.
- ↳ ET-132118 - 1pc.
- ↳ ET-131156 - 1pc.
- ↳ ET-131113 - 1pc.

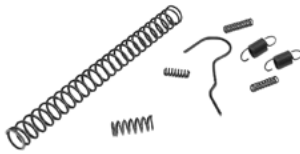

EEMANN TECH SPRINGS SET FOR CZ P-10

Reference nr.

ET-130112

NEW

- ↳ ET-130091 - 1pc.
- ↳ ET-130093 - 1pc.
- ↳ ET-190094 - 1pc.
- ↳ ET-130095 - 1pc.
- ↳ ET-130096 - 1pc.
- ↳ ET-130097 - 1pc.
- ↳ ET-130098 - 1pc.



EEMANN TECH COMPETITION SPRINGS KIT FOR CZ P-10

Reference nr.

ET-130117

NEW

- ↳ ET-130092 - 1pc.
- ↳ ET-130075 - 2pc.



EEMANN TECH FOLLOWER KIT FOR CZ MEC-GAR MAGAZINE

Reference nr.

ET-130125

NEW

Eemann Tech Competition Recoil Spring for CZ



THE EEMANN TECH COMPETITION RECOIL SPRING FOR CZ

Reference nr.	Spring weight	Color
ET-131177	7 lbs	Green
ET-131178	8 lbs	Black
ET-131179	9 lbs	Brown
ET-131180	10 lbs	Pink
ET-131181	11 lbs	Light Green
ET-131182	12 lbs	Blue
ET-131183	13 lbs	White

The Eemann Tech Competition Recoil Spring has been specially designed for:

- CZ 75 SP-01 Shadow
- CZ Shadow 2

The spring also fits all CZ 75 pistols with Long Recoil Spring Guide Rods.



Precise your **power** with colors

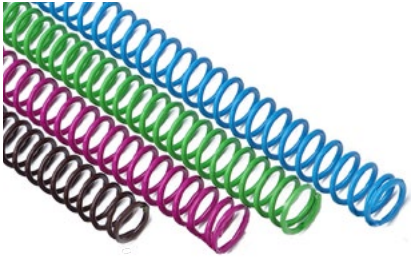

EEMANN TECH RECOIL SPRINGS CALIBRATION PACK FOR CZ

Reference nr.	Spring weight	Color
ET-131199		
↳ ET-131179	9 lbs - 1 pc.	■
↳ ET-131180	10 lbs - 1 pc.	■
↳ ET-131181	11 lbs - 1 pc.	■
↳ ET-131182	12 lbs - 1 pc.	■



EEMANN TECH RECOIL SPRING FOR CZ 75

Reference nr.	Spring weight
ET-131137	7 lbs
ET-131138	8 lbs
ET-131139	9 lbs
ET-131140	10 lbs
ET-131141	11 lbs
ET-131142	12 lbs
ET-131143	13 lbs
ET-131144	14 lbs
ET-131145	15 lbs
ET-131146	16 lbs
ET-131159	18 lbs
ET-131158	20 lbs



EEMANN TECH RECOIL SPRING FOR CZ P-10F

Reference nr.	Spring weight	
ET-130240	10 lbs	NEW
ET-130241	11 lbs	NEW
ET-130242	12 lbs	NEW
ET-130243	13 lbs	NEW
ET-130244	14 lbs	NEW
ET-130245	15 lbs	NEW
ET-130246	16 lbs	NEW



EEMANN TECH MAGAZINE SPRING FOR CZ CZECHMATE

Reference nr.

ET-131157

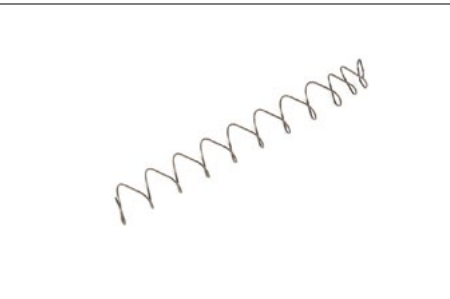

EEMANN TECH MAGAZINE SPRING FOR CZ 75 TACTICAL SPORTS, 9X19/.40SW

Reference nr.

ET-131149

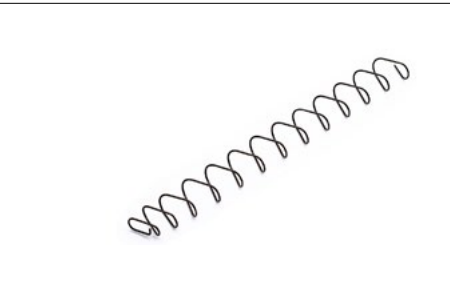

EEMANN TECH COMPETITION EXTENDED MAGAZINE SPRING FOR CZ

Reference nr.

ET-132170

NEW



EEMANN TECH MAGAZINE SPRING FOR
CZ 75, 16 ROUNDS MAGAZINE

Reference nr.

ET-131150



EEMANN TECH MAGAZINE SPRING
(OEM 18 ROUNDS) FOR CZ 75 SP-01 SHADOW

Reference nr.

ET-131147

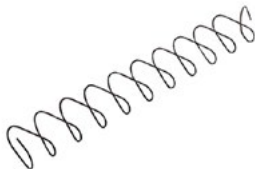

EEMANN TECH MAGAZINE SPRING
(MEC-GAR 19 ROUNDS) FOR CZ SHADOW 2

Reference nr.

ET-131148

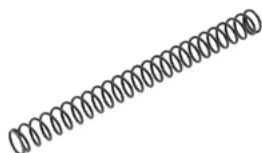

EEMANN TECH FIRING PIN SPRING FOR CZ P-10

Reference nr.

ET-130091



EEMANN TECH MAIN SPRINGS CALIBRATION PACK FOR CZ

Reference nr.	Spring weight	Color
ET-131184		
↳ ET-131187	7 lbs- 1 pc.	■
↳ ET-131188	8 lbs- 1 pc.	■
↳ ET-131189	9 lbs- 1 pc.	■
↳ ET-131190	10 lbs- 1 pc.	■
↳ ET-131193	13 lbs - 1 pc.	□



EEMANN TECH MAIN SPRING FOR CZ 75, CZ SHADOW 2

Reference nr.	Spring weight	
ET-131117	7 lbs	
ET-131118	8 lbs	
ET-131119	9 lbs	
ET-131120	10 lbs	
ET-131121	11 lbs	
ET-131122	12 lbs	
ET-131123	13 lbs	
ET-131126	16 lbs	
ET-131128	18 lbs	NEW



EEMANN TECH COMPETITION MAIN SPRING FOR CZ

Reference nr.	Spring weight
ET-131187	7 lbs
ET-131188	8 lbs
ET-131189	9 lbs
ET-131190	10 lbs
ET-131193	13 lbs



EEMANN TECH COMPETITION FIRING PIN SPRING FOR CZ P-10

Reference nr.
ET-130092



EEMANN TECH DISASSEMBLY PLATE SPRING
FOR CZ P-10

Reference nr.

ET-130098



EEMANN TECH TRIGGER BAR DISCONNECTOR
SPRING FOR CZ P-10

Reference nr.

ET-130097



EEMANN TECH MAGAZINE CATCH SPRING FOR
CZ P-10

Reference nr.

ET-130096



EEMANN TECH FIRING PIN SPRING FOR CZ 75,
CZ SHADOW 2

Reference nr.

ET-131155



EEMANN TECH FIRING PIN SPRING LIGHT
(-15% POWER) FOR CZ 75, CZ SHADOW 2*

Reference nr.

ET-131156

*15% less from factory power



EEMANN TECH SAFETY DETENT PLUNGER
SPRING FOR CZ 75, CZ SHADOW 2

Reference nr.

ET-131131



EEMANN TECH TRIGGER BAR SPRING FOR
CZ P-10 - 2PCS./SET

Reference nr.

ET-130095

* Factory power



EEMANN TECH COMPETITION TRIGGER BAR
SPRING FOR CZ P-10 - 2PCS./SET

Reference nr.

ET-130075



EEMANN TECH SAFETY DETENT PLUNGER LEFT
FOR CZ

Reference nr.

ET-130133

NEW



EEMANN TECH SAFETY DETENT PLUNGER RIGHT
FOR CZ

Reference nr.

ET-130134

NEW



EEMANN TECH EJECTOR SPRINGS SET FOR
CZ 75 TACTICAL SPORT*

Reference nr.

ET-132174

*Two pieces set



EEMANN TECH SEAR SPRING FOR CZ P-07/P-09

Reference nr.

ET-130106



EEMANN TECH SAFETY LATCH SPRING FOR
CZ P-07/P-09

Reference nr.

ET-130107



EEMANN TECH EXTRACTOR SPRING FOR
CZ P-07/P-09/P-10

Reference nr.

ET-130093



EEMANN TECH EXTREME EXTRACTOR SPRING
(+10% POWER) FOR CZ 75

Reference nr.

ET-131153



EEMANN TECH EXTRACTOR SPRING FOR CZ 75,
CZ SHADOW 2

Reference nr.

ET-131152

ET-132152

Caliber

9×19/9×21mm

.40S&W



EEMANN TECH TRIGGER BAR SPRING FOR
CZ 75, CZ SHADOW 2*

Reference nr.

ET-131134



EEMANN TECH COMPETITION TRIGGER BAR
SPRING (-15% POWER) FOR CZ*

Reference nr.

ET-131201

*15% less from factory power



EEMANN TECH MAGAZINE CATCH RELEASE
SPRING FOR CZ 75, CZ SHADOW 2

Reference nr.

ET-131133



EEMANN TECH COMPETITION MAGAZINE CATCH
RELEASE SPRING (-10% POWER) FOR CZ 75, CZ
SHADOW 2

Reference nr.

ET-131200



EEMANN TECH SLIDE STOP SPRING FOR
CZ 75, CZ SHADOW 2

Reference nr.

ET-131103



EEMANN TECH SLIDE STOP SPRING FOR CZ P-10

Reference nr.

ET-130094



EEMANN TECH HAMMER DECOCKING LEVER
SPRING FOR CZ P-07/P-09

Reference nr.

ET-130099



EEMANN TECH SEAR SPRING FOR CZ 75,
CZ SHADOW 2

Reference nr.

ET-131112



EEMANN TECH COMPETITION SEAR SPRING
(-10% POWER) FOR CZ 75, CZ SHADOW 2*

Reference nr.

ET-131113

*10% less from factory power



EEMANN TECH TRIGGER SPRING FOR
CZ 75, CZ SHADOW 2

Reference nr.

ET-131108



EEMANN TECH COMPETITION TRIGGER SPRING
(-15% POWER) FOR CZ 75, CZ SHADOW 2*

Reference nr.

ET-131109

*15% less from factory power



EEMANN TECH EXTREME TRIGGER SPRING
(+10% POWER) FOR CZ 75, CZ SHADOW 2*

Reference nr.

ET-131110

*10% more from factory power



EEMANN TECH COMPETITION TRIGGER SPRING
(-15% POWER) FOR CZ 75 TACTICAL SPORT*

Reference nr.

ET-132118

*15% less from factory power



EEMANN TECH EXTENDED COMPETITION SEAR
SPRING (-10% POWER) FOR CZ 75, CZ SHADOW 2*

Reference nr.

ET-131114

*10% less from factory power



EEMANN TECH TRIGGER SPRING FOR CZ TS / TS2

Reference nr.

ET-131298

NEW

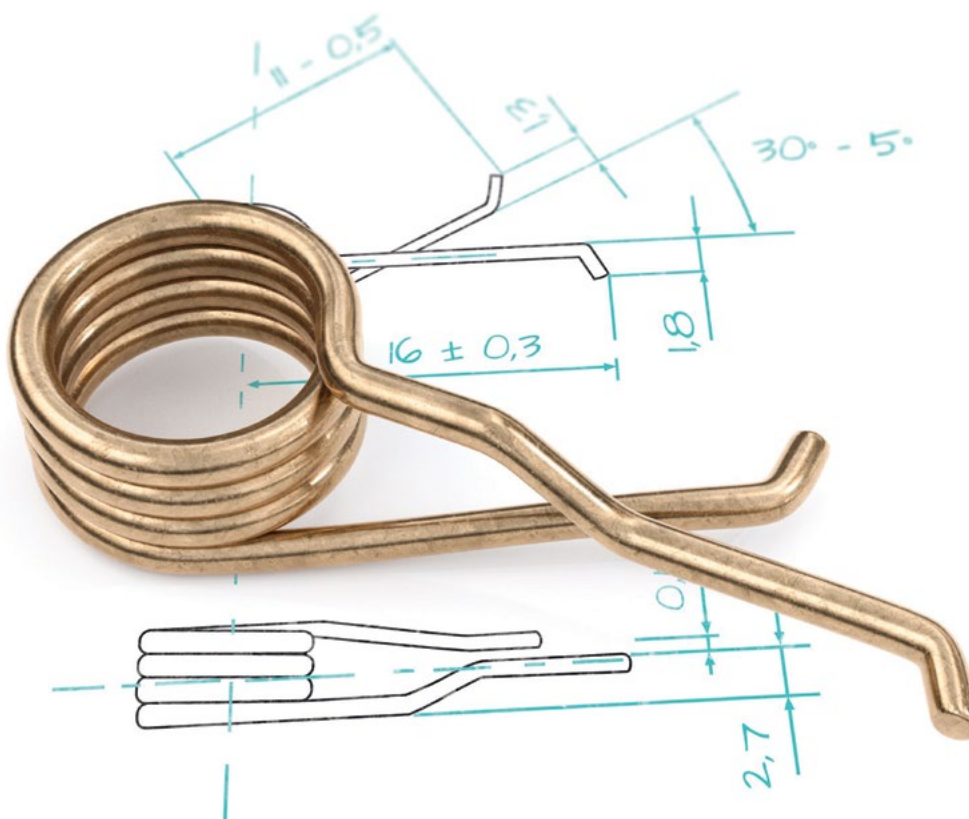

The **accuracy** on every level



EEMANN TECH SPRINGS KIT FOR ADAPTER CZ SHADOW 2 KADET

Reference nr.

ET-132200

- ↳ ET-132201 - 1pc.
- ↳ ET-132202 - 1pc.
- ↳ ET-132203 - 1pc.
- ↳ ET-132204 - 1pc.
- ↳ ET-132205 - 1pc.
- ↳ ET-132208 - 1pc.



EEMANN TECH EXTRACTOR SPRING FOR ADAPTER CZ SHADOW 2 KADET

Reference nr.

ET-132202



EEMANN TECH FIRING PIN SPRING FOR ADAPTER CZ SHADOW 2 KADET

Reference nr.

ET-132203



EEMANN TECH RECOIL SPRING FOR ADAPTER CZ SHADOW 2 KADET - WEAK (BLUE)

Reference nr.

ET-132205



EEMANN TECH RECOIL SPRING FOR ADAPTER CZ SHADOW 2 KADET - STRONG (RED)

Reference nr.

ET-132204



EEMANN TECH RECOIL SPRING FOR ADAPTER CZ SHADOW 2 KADET

Reference nr.

ET-132201



EEMANN TECH MAGAZINE SPRING FOR ADAPTER CZ SHADOW 2 KADET

Reference nr.

ET-132208



EEMANN
TECH THE BEST PERFORMANCE





EEMANN TECH RECOIL SPRING FOR
CZ SCORPION EVO 3

Reference nr.

ET-133031

EEMANN TECH EJECTOR SPRING FOR CZ
SCORPION EVO 3

Reference nr.

ET-133088

NEW

EEMANN TECH SPRINGS KIT FOR CZ SCORPION
EVO 3

Reference nr.

ET-133004

- ↳ ET-133002
- ↳ ET-133003
- ↳ ET-133027
- ↳ ET-133029
- ↳ ET-133033
- ↳ ET-133034



EEMANN TECH STRIKING MECHANISM SPRING
FOR CZ SCORPION EVO 3

Reference nr.

ET-133033



EEMANN TECH HAMMER SPRING FOR CZ
SCORPION EVO 3

Reference nr.

ET-133034



EEMANN TECH DISCONNECTOR SPRING FOR CZ
SCORPION EVO 3

Reference nr.

ET-133002



EEMANN TECH COMPETITION TRIGGER SPRING
FOR CZ SCORPION EVO 3

Reference nr.

ET-133003

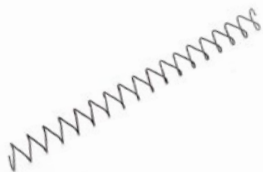

EEMANN TECH MAGAZINE SPRING FOR CZ
SCORPION EVO 3

Reference nr.

ET-133035



EEMANN TECH COMPETITION TRIGGER
SPRINGS KIT FOR CZ SCORPION EVO 3

Reference nr.

ET-133001



EEMANN TECH FIRING PIN SPRING FOR
CZ SCORPION EVO 3

Reference nr.

ET-133027



Eemann Tech Progressive Recoil Spring for 1911/2011

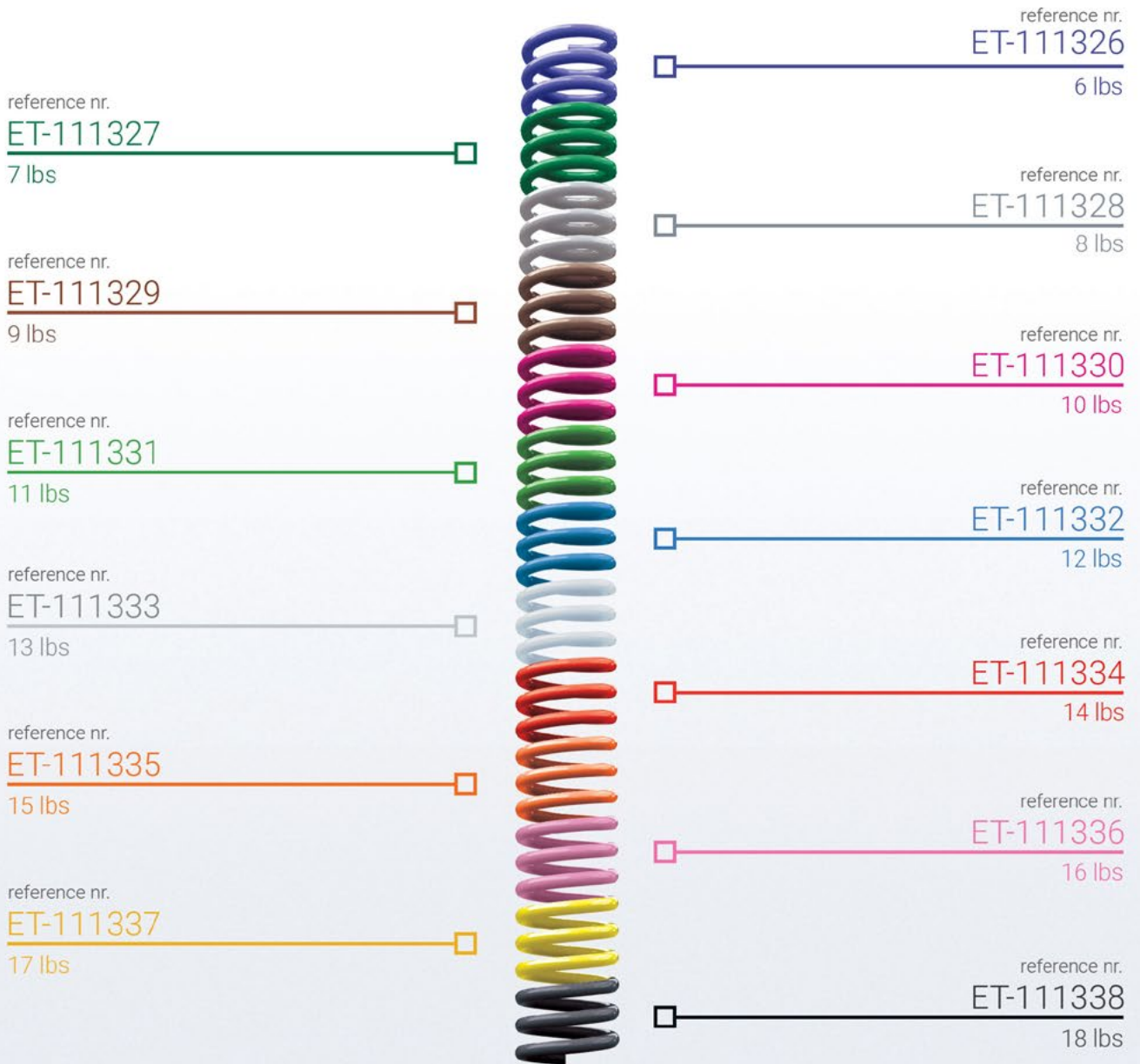

A wide selection for every preference



Eemann Tech Progressive Recoil Spring

The Eemann Tech Progressive Recoil Spring for 1911/2011 differs from the factory recoil spring in distance between coils. The progressive recoil spring coils are constantly reducing from the center to the end of the spring. The first part of the spring has standard factory coil gaps and is the strongest part.

The part with the “factory” coil gap starts compressing first and after the first coils impact the second part with “progressive” coil distance, they join together for faster recoil reducing to zero. At the end of the compression cycle, the progressive recoil spring’s power is ~10% greater than the declared value. As a result, if you use a weaker spring, the springs capacity remains the same.

Every spring’s power value is indicated by a unique color, that allows identifying the spring’s original power at any moment of its life. The Eemann Tech Progressive Recoil Springs are painted by a special polymer paint with thermal treatment, which remains elastic throughout the life of the spring. There are

special calibration packs for different types of handguns / IPSC divisions. Every calibration pack contains 4 springs of different power, for more precise calibration of the handgun for individual types of ammunition.

For maximum efficiency, it is recommended to use the Eemann Tech Progressive Recoil Spring with Eemann Tech Recoil Buffer (Reference code: ET-303011).

The Eemann Tech Progressive Recoil Spring has power selection from 6-18 lbs. This variety of spring power values allows them to be used with any type of handguns from OPEN division (6-7 lbs) to the Classic Major .45 caliber and factory ammunition with a light bullet (18 lbs).

When installing the Eemann Tech Progressive Recoil Spring, the strengthened part of the spring should be directed towards the chamber.



Eemann Tech Progressive Recoil Spring for 1911/2011



EEMANN TECH PROGRESSIVE RECOIL SPRING FOR 1911/2011



Reference nr.	Spring weight	Color
ET-111326	6 lbs	Blue
ET-111327	7 lbs	Green
ET-111328	8 lbs	Grey
ET-111329	9 lbs	Brown
ET-111330	10 lbs	Pink
ET-111331	11 lbs	Light Green
ET-111332	12 lbs	Cyan
ET-111333	13 lbs	White
ET-111334	14 lbs	Red
ET-111335	15 lbs	Orange
ET-111336	16 lbs	Purple
ET-111337	17 lbs	Yellow
ET-111338	18 lbs	Black

Choose your spring **color**



EEMANN TECH COMPETITION SPRINGS KIT FOR 1911 IN .45 CALIBER

Reference nr.

ET-119045

NEW



EEMANN TECH MAIN SPRINGS CALIBRATION PACK FOR 1911/2011

Reference nr.

Spring weight

Color

ET-119012

- ↳ ET-111160 14 lbs - 1 pc. ■
- ↳ ET-111161 15 lbs - 1 pc. ■
- ↳ ET-111162 16 lbs - 1 pc. ■
- ↳ ET-111163 17 lbs - 1 pc. ■
- ↳ ET-111164 18 lbs - 1 pc.



EEMANN TECH SPRINGS KIT FOR 1911/2011

Reference nr.

ET-119010

NEW

- ↳ ET-114118
- ↳ ET-111164
- ↳ ET-111040
- ↳ ET-111200
- ↳ ET-111080
- ↳ ET-111110



EEMANN TECH COMPETITION SPRINGS KIT FOR 1911/2011

Reference nr.

ET-119011

NEW

- ↳ ET-111333
- ↳ ET-111160
- ↳ ET-111222
- ↳ ET-111081

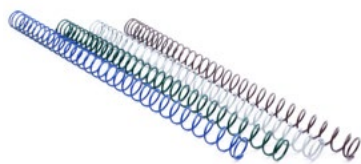

EEMANN TECH RECOIL SPRINGS CALIBRATION PACK "OPEN MAJOR" FOR 2011

Reference nr.	Spring weight	Color
ET-119001		
↳ ET-111326	6 lbs - 1 pc.	Blue
↳ ET-111327	7 lbs - 1 pc.	Green
↳ ET-111328	8 lbs - 1 pc.	Grey
↳ ET-111329	9 lbs - 1 pc.	Brown



EEMANN TECH RECOIL SPRINGS CALIBRATION PACK "STANDARD/CLASSIC MINOR" FOR 1911/2011

Reference nr.	Spring weight	Color
ET-119002		
↳ ET-111329	9 lbs - 1 pc.	Brown
↳ ET-111330	10 lbs - 1 pc.	Pink
↳ ET-111331	11 lbs - 1 pc.	Green
↳ ET-111332	12 lbs - 1 pc.	Cyan



EEMANN TECH RECOIL SPRINGS CALIBRATION PACK "STANDARD MAJOR" FOR 2011

Reference nr.	Spring weight	Color
ET-119003		
↳ ET-111332	12 lbs - 1 pc.	Cyan
↳ ET-111333	13 lbs - 1 pc.	Grey
↳ ET-111334	14 lbs - 1 pc.	Red
↳ ET-111335	15 lbs - 1 pc.	Orange



EEMANN TECH RECOIL SPRINGS CALIBRATION PACK "CLASSIC MAJOR" FOR 1911

Reference nr.	Spring weight	Color
ET-119004		
↳ ET-111335	15 lbs - 1 pc.	Orange
↳ ET-111336	16 lbs - 1 pc.	Pink
↳ ET-111337	17 lbs - 1 pc.	Yellow
↳ ET-111338	18 lbs - 1 pc.	Black



Eemann Tech Recoil Spring for 1911/2011 5" Barrel

Recoil springs are available in different power specifications for the recoil function to suit individual needs. Made of steel, with thermic treatment for the best performance and quality!

EEMANN TECH RECOIL SPRING FOR 1911/2011

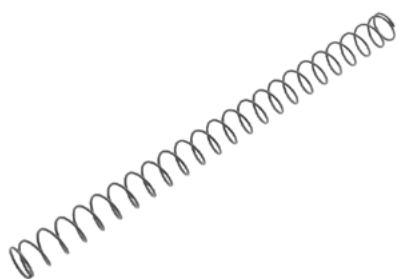

Reference nr.	Spring weight
ET-114106	6 lbs
ET-114108	8 lbs
ET-114110	10 lbs
ET-114112	12 lbs
ET-114114	14 lbs
ET-114116	16 lbs
ET-114118	18 lbs
ET-114120	20 lbs
ET-144122	22 lbs
ET-114122	24 lbs



EEMANN TECH 120 MM STANDARD MAGAZINE
SPRING FOR 2011

Reference nr.

ET-111301



EEMANN TECH 120 MM HIGH CAPACITY
MAGAZINE SPRING FOR 2011

Reference nr.

ET-111302



EEMANN TECH MAGAZINE SPRING FOR MBX STI
126MM MAGAZINE

Reference nr.

ET-111307



EEMANN TECH 140 MM STANDARD MAGAZINE
SPRING FOR 2011

Reference nr.

ET-111303



EEMANN TECH 140 MM HIGH CAPACITY
MAGAZINE SPRING FOR 2011

Reference nr.

ET-111304



EEMANN TECH 170 MM STANDARD MAGAZINE
SPRING FOR 2011

Reference nr.

ET-111305



EEMANN TECH 170 MM HIGH CAPACITY
MAGAZINE SPRING FOR 2011

Reference nr.

ET-111306



EEMANN TECH SINGLE STACK MAGAZINE SPRING
FOR 1911

Reference nr.

ET-111550

ET-111551

Caliber

.45AUTO

9×19mm



EEMANN TECH MAIN SPRING FOR 1911/2011

Reference nr.	Spring weight
ET-111160	14 lbs
ET-111161	15 lbs
ET-111162	16 lbs
ET-111163	17 lbs
ET-111164	18 lbs



EEMANN TECH MAGAZINE CATCH SPRING FOR 1911/2011

Reference nr.
ET-111080

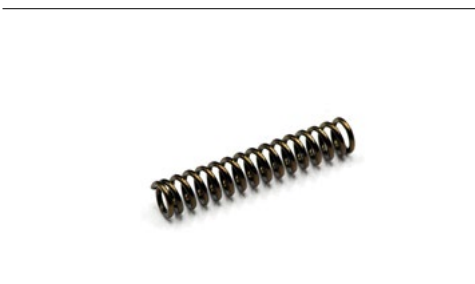

EEMANN TECH MAGAZINE CATCH SPRING LIGHT FOR 1911/2011*

Reference nr.
ET-111081

* -15% less from ET-111080



EEMANN TECH SAFETY LOCK PLUNGER SPRING FOR 1911/2011

Reference nr.
ET-111110



EEMANN TECH FIRING PIN SPRING FOR 1911/2011

Reference nr.
ET-111040





EEMANN TECH SEAR SPRING FOR 1911/2011

Reference nr.

ET-111200



EEMANN TECH COMPETITION SEAR SPRING FOR 1911/2011

Reference nr.

ET-111222

NEWSPARE SPRING SET FOR EEMANN TECH
COMPETITION EXTRACTOR 1911/2011

Reference nr.

ET-111033





EEMANN TECH UPGRADE KIT FOR TANFOGLIO

Reference nr.

ET-150006

NEW

Eemann Tech Upgrade Kit ET-150006 for Tanfoglio contains:

- ET-152010 Eemann Tech Competition Disconnecter for Tanfoglio - 1pc.
- ET-150003 Eemann Tech Disconnecter Pin for Tanfoglio - 1pc.
- ET-151830 Eemann Tech Recoil Spring for Tanfoglio 10 lbs - 1pc.
- ET-151433 Eemann Tech Hammer Spring for Tanfoglio 13 lbs - 1pc.
- ET-151331 Eemann Tech Competition Trigger Spring for Tanfoglio - 1pc.
- ET-303015 Eemann Tech Competition Buffer for Tanfoglio - 1pc.

Compatible with:

- Tanfoglio STOCK II, III or similar
- Tanfoglio Xtreme II, III or similar



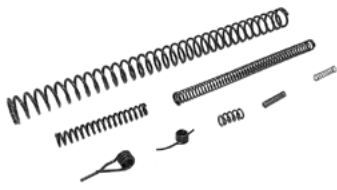

EEMANN TECH SPRINGS KIT FOR TANFOGLIO

Reference nr.

ET-151001

NEW

- ↳ ET-151835 - 1pc.
- ↳ ET-151430 - 1pc.
- ↳ ET-151330 - 1pc.
- ↳ ET-151530 - 1pc.
- ↳ ET-151930 - 1pc.
- ↳ ET-151680 - 1pc.
- ↳ ET-151560 - 1pc.
- ↳ ET-151113 - 1pc.

Compatible with:

- Tanfoglio STOCK II, III or similar
- Tanfoglio Xtreme II, III or similar



EEMANN TECH COMPETITION SPRINGS KIT FOR TANFOGLIO

Reference nr.

ET-152011

NEW

- ↳ ET-151830 - 1pc.
- ↳ ET-151433 - 1pc.
- ↳ ET-151331 - 1pc.
- ↳ ET-151530 - 1pc.
- ↳ ET-151930 - 1pc.
- ↳ ET-151680 - 1pc.
- ↳ ET-151560 - 1pc.
- ↳ ET-151113 - 1pc.

Compatible with:

- Tanfoglio STOCK II, III or similar
- Tanfoglio Xtreme II, III or similar



EEMANN TECH RECOIL SPRING FOR TANFOGLIO

Reference nr.	Caliber
ET-151828	8 lbs
ET-151829	9 lbs
ET-151830	10 lbs
ET-151831	11 lbs
ET-151832	12 lbs
ET-151833	13 lbs
ET-151834	14 lbs
ET-151835	15 lbs
ET-151836	16 lbs
ET-151837	17 lbs



EEMANN TECH MAGAZINE SPRING FOR TANFOGLIO

Reference nr.	Caliber
ET-151610	9×19mm
ET-151611	.40S&W

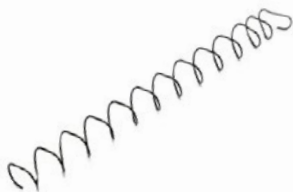

EEMANN TECH OPEN MAGAZINE SPRING 170 MM FOR TANFOGLIO

Reference nr.	Caliber
ET-151612	



EEMANN TECH HAMMER SPRING FOR TANFOGLIO

Reference nr.	Spring weight
ET-151432	12 lbs
ET-151433	13 lbs
ET-151430*	16 lbs

*Factory power



EEMANN TECH MAGAZINE CATCH SPRING FOR TANFOGLIO

Reference nr.
ET-151680



EEMANN TECH TRIGGER SPRING FOR TANFOGLIO

Reference nr.

ET-151330

EEMANN TECH COMPETITION TRIGGER SPRING
(-15% POWER) FOR TANFOGLIO***Reference nr.**

ET-151331

*15% less from factory power



EEMANN TECH SEAR SPRING FOR TANFOGLIO

Reference nr.

ET-151930

EEMANN TECH EXTRACTOR SPRING FOR
TANFOGLIO**Reference nr.**

ET-151113

EEMANN TECH FIRING PIN SAFETY SPRING
FOR TANFOGLIO**Reference nr.**

ET-151560

EEMANN TECH FIRING PIN SPRING FOR
TANFOGLIO**Reference nr.**

ET-151530

EEMANN TECH COMPETITION FIRING PIN SPRING
FOR TANFOGLIO**Reference nr.**

ET-151540

NEW



EEMANN
TECH WWW.EEMANN.TECH

Eemann Tech Competition Springs Kit For GLOCK GEN5



EEMANN TECH COMPETITION SPRINGS KIT FOR GLOCK GEN5

Reference nr.

ET-121026

- ↳ ET-121003
- ↳ ET-121020
- ↳ ET-121005

The Eemann Tech GLOCK GEN5 Competition Springs Kit contains:

- ET-121005 - Eemann Tech GLOCK Competition Firing Pin Safety Spring for Glock Gen5 (Reduced power) - lightens the work of the trigger mechanism.
- ET-121020 - Eemann Tech Competition Trigger Spring for GLOCK Gen5 - This spring helps you to pull the trigger easier.
- ET-121003 - Eemann Tech GLOCK Firing Pin Spring for GLOCK Gen3/4/5 4lbs (Reduced power) - lightens the work of the trigger mechanism.

NOTE: We cannot guarantee that the trigger safety will function correctly after installation of the whole kit, as the kit contains a competition spring.

The Eemann Tech GLOCK Competition Springs Kit allows you to lighten the trigger pull weight of your GLOCK GEN5

The GLOCK trigger pull weight is determined by spring weight and glock connector.



EEMANN TECH COMPETITION STRIKER SPRINGS PACK FOR GLOCK

Reference nr.	Spring weight	Color
ET-120030		
↳ ET-121021	2.5 lbs	☐
↳ ET-121024	3 lbs	■
↳ ET-121435	3.5 lbs	■
↳ ET-121003	4 lbs	■



EEMANN TECH COMPETITION SPRINGS KIT FOR GLOCK GEN 3/4

Reference nr.
ET-121018
↳ ET-121003
↳ ET-121004
↳ ET-121005



EEMANN TECH COMPETITION SPRINGS KIT FOR GLOCK 43/43X

Reference nr.
ET-121043
↳ ET-121005
↳ ET-121020
↳ ET-121003



EEMANN TECH RECOIL SPRINGS CALIBRATION PACK FOR GLOCK 17-22-34-35

Reference nr.
ET-121035



EEMANN TECH COMPETITION RECOIL SPRING FOR GLOCK 17-22-34-35

Reference nr.	Spring weight	Color	
ET-121710	10 lbs	Yellow	NEW
ET-121711	11 lbs	Blue	NEW
ET-121712	12 lbs	Red	NEW
ET-121713	13 lbs	Green	NEW
ET-121714	14 lbs	Orange	NEW
ET-121716	16 lbs	White	NEW



EEMANN TECH RECOIL SPRING ASSEMBLY FOR GLOCK19 GEN3

Reference nr.	
ET-122034	NEW



EEMANN TECH RECOIL SPRING ASSEMBLY FOR GLOCK17 GEN3

Reference nr.	
ET-122033	NEW



EEMANN TECH RECOIL SPRING FOR GLOCK 17-22-34-35

Reference nr.	Spring weight
ET-121010	10 lbs
ET-121011	11 lbs
ET-121012	12 lbs
ET-121013	13 lbs
ET-121014	14 lbs
ET-121015	15 lbs
ET-121016	16 lbs



EEMANN TECH RECOIL SPRING FOR GLOCK 19-23

Reference nr.	Spring weight
ET-120190	10 lbs
ET-120191	11 lbs
ET-120192	12 lbs
ET-120193	13 lbs
ET-120194	14 lbs
ET-120195	15 lbs



EEMANN TECH MAGAZINE SPRING FOR GLOCK 17 GEN 5

Reference nr.
ET-121031



EEMANN TECH MAGAZINE SPRING FOR 17 ROUNDS GLOCK 19-23 MAGAZINE

Reference nr.	Rounds amount
ET-121007	17
ET-121008	17+2
ET-121009	15
ET-121017	33



EEMANN TECH CUSTOM SPRING FOR GLOCK MAGAZINE 33 ROUNDS

Reference nr.
ET-121050



EEMANN TECH TRIGGER SPRING FOR GLOCK GEN5

Reference nr.

ET-121030



EEMANN TECH COMPETITION TRIGGER SPRING FOR GLOCK GEN5*

Reference nr.

ET-121020

*10% more power from factory spring



EEMANN TECH TRIGGER SPRING FOR GLOCK GEN 3/4

Reference nr.

ET-122017



EEMANN TECH COMPETITION TRIGGER SPRING FOR GLOCK GEN 3/4*

Reference nr.

ET-121004

*10% more power from factory spring

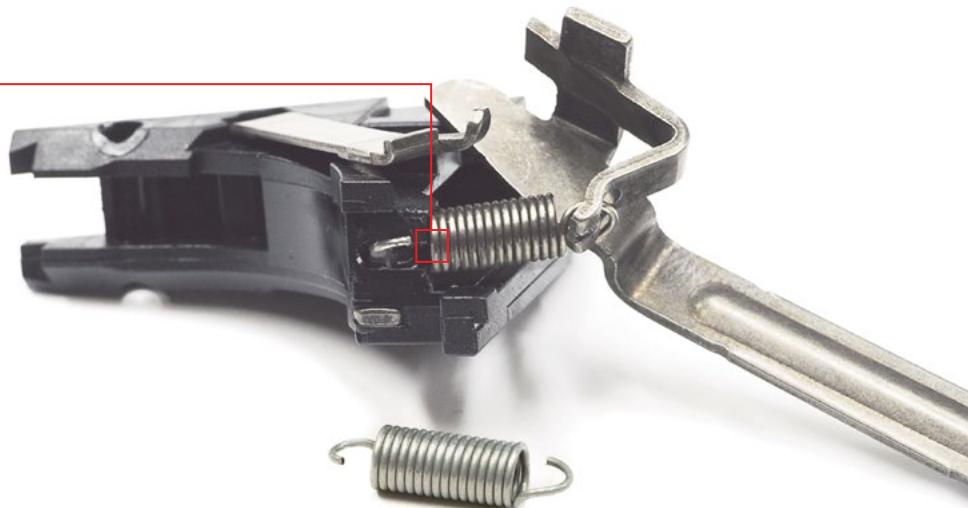



EEMANN TECH SLIDE LOCK SPRING FOR
GLOCK 17

Reference nr.

ET-122014



EEMANN TECH SLIDE LOCK SPRING FOR
GLOCK 19

Reference nr.

ET-122022



EEMANN TECH MAGAZINE CATCH SPRING
FOR GLOCK

Reference nr.

ET-122013



EEMANN TECH COMPETITION FIRING PIN
SPRING FOR GLOCK

Reference nr.	Spring weight
ET-121021	2,5 lbs
ET-121024	3 lbs
ET-121435	3.5 lbs
ET-121003	4 lbs
ET-121045	4,5 lbs

NEW



EEMANN TECH EXTRA POWER RETURN SPRING
FOR GLOCK TRIGGERS

Reference nr.

ET-120070

NEW



EEMANN TECH COMPETITION FIRING PIN
SAFETY SPRING FOR GLOCK*

Reference nr.

ET-121005

*10% less from factory power





EEMANN TECH RECOIL SPRING FOR SIG SAUER P226

Reference nr. **Spring weight**

ET-141012 9 lbs

ET-141013 10 lbs

ET-141014 11 lbs

ET-141015 12 lbs

ET-141016* 13 lbs

*Factory power



EEMANN TECH RECOIL SPRING FOR SIG SAUER MPX

Reference nr.

ET-143804

NEW



EEMANN TECH TRIGGER BAR SPRING FOR SIG SAUER P226

Reference nr.

ET-141001



EEMANN TECH HAMMER RESET SPRING FOR SIG SAUER P226

Reference nr.

ET-141002



EEMANN TECH SEAR SPRING FOR SIG SAUER P226

Reference nr.

ET-141003



EEMANN TECH FIRING PIN SPRING FOR SIG SAUER P226

Reference nr.

ET-141004



EEMANN TECH TRIGGER BAR SPRING FOR
SIG SAUER P320

Reference nr.

ET-142004



EEMANN TECH SEAR SPRING FOR
SIG SAUER P320

Reference nr.

ET-142005



EEMANN TECH STRIKER SPRING FOR
SIG SAUER P320

Reference nr.

ET-142006



EEMANN TECH STRIKER SAFETY LOCK SPRING
FOR SIG SAUER P320

Reference nr.

ET-142007



EEMANN TECH TAKEDOWN SAFETY LEVEL
SPRING FOR SIG SAUER P320

Reference nr.

ET-142008



EEMANN TECH MAGAZINE CATCH SPRING FOR
SIG SAUER P320

Reference nr.

ET-142009



EEMANN TECH FIRING PIN SPRING LIGHT
(-15% POWER) FOR SIG SAUER P226*

Reference nr.

ET-141005*

15% less from ET-141004 (factory power)



EEMANN TECH FIRING PIN SPRING FOR SIG
SAUER MPX

Reference nr.

ET-143051



EEMANN TECH MAIN SPRING FOR
SIG SAUER P226

Reference nr. **Spring weight**

ET-141006 13 lbs

ET-141007 14 lbs

ET-141008 15 lbs

ET-141009 16 lbs

ET-141010 17 lbs

ET-141011* 19 lbs

*Factory power



EEMANN TECH SLIDE CATCH LEVEL SPRING FOR
SIG SAUER P320

Reference nr.

ET-142002



EEMANN TECH SAFETY LEVER SPRING FOR
SIG SAUER P320

Reference nr.

ET-142003



EEMANN TECH COMPETITION SPRINGS KIT FOR BERETTA 92/96/98

Reference nr.

ET-242092

- ↳ ET-241045
- ↳ ET-241046
- ↳ ET-241047
- ↳ ET-241048
- ↳ ET-241009
- ↳ ET-241032

Compatible with:

- Beretta 92/96/98 and their models

All the springs in this kit are made for the best performance in competition and to produce better competition results.

If you're wanting to upgrade your Beretta 92/96/98 and their models for competition, this is the right kit for you.



EEMANN TECH SPRINGS KIT FOR BERETTA 92/96/98

Reference nr.

ET-242100

- ↳ ET-241013
- ↳ ET-241015
- ↳ ET-241016
- ↳ ET-241017
- ↳ ET-241018
- ↳ ET-241019
- ↳ ET-241020
- ↳ ET-241021
- ↳ ET-241022
- ↳ ET-241024
- ↳ ET-241023
- ↳ ET-241025
- ↳ ET-241026



EEMANN TECH RECOIL SPRING FOR BERETTA

Reference nr.

ET-241008

EEMANN TECH MAIN SPRING FOR BERETTA
92/96/98

Reference nr.

ET-241024

EEMANN TECH MAGAZINE SPRING FOR BERETTA
92FS / 92X - 18 ROUNDS

Reference nr.

ET-241049

NEW

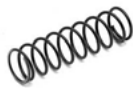
EEMANN TECH FIRING PIN SPRING FOR BERETTA
92/96/98

Reference nr.

ET-241015

EEMANN TECH FIRING PIN BLOCK SPRING FOR
BERETTA 92/96/98

Reference nr.

ET-241016

EEMANN TECH EXTRACTOR SPRING FOR BERETTA
92/96/98

Reference nr.

ET-241017



EEMANN TECH DISASSEMBLY SPRING FOR
BERETTA 92/96/98

Reference nr.

ET-241019



EEMANN TECH SLIDE STOP SPRING FOR BERETTA
92/96/98

Reference nr.

ET-241020



EEMANN TECH TRIGGER SPRING FOR BERETTA
92/96/98

Reference nr.

ET-241021



EEMANN TECH TRIGGER BAR SPRING FOR
BERETTA 92/96/98

Reference nr.

ET-241022



EEMANN TECH MAGAZINE CATCH SPRING FOR
BERETTA 92/96/98

Reference nr.

ET-241023



EEMANN TECH LEFT SAFETY PLUNGER SPRING
FOR BERETTA 92/96/98

Reference nr.

ET-241018



EEMANN TECH SEAR SPRING FOR BERETTA
92/96/98

Reference nr.

ET-241025



EEMANN TECH RIGHT SAFETY SPRING FOR
BERETTA 92/96/98

Reference nr.

ET-241026



EEMANN TECH COMPETITION FIRING PIN SPRING
FOR BERETTA 92/96/98

Reference nr.

ET-241045



EEMANN TECH COMPETITION TRIGGER SPRING
FOR BERETTA 92/96/98

Reference nr.

ET-241046



EEMANN TECH COMPETITION TRIGGER BAR
SPRING FOR BERETTA 92/96/98

Reference nr.

ET-241047



EEMANN TECH COMPETITION SEAR SPRING FOR
BERETTA 92/96/98

Reference nr.

ET-241048



EEMANN TECH TRIGGER SPRING FOR BERETTA
APX

Reference nr.

ET-241144

NEW



EEMANN TECH STRIKER BLOCK SPRING FOR
BERETTA APX

Reference nr.

ET-241146

NEW



EEMANN TECH COCKING LEVER SPRING FOR
BERETTA APX

Reference nr.

ET-241149

NEW



EEMANN TECH FIRING PIN BACK SPRING FOR
BERETTA APX

Reference nr.

ET-241148

NEW



EEMANN TECH EJECTOR SPRING FOR BERETTA
A400

Reference nr.

ET-243316

NEW



EEMANN TECH EJECTOR SPRING FOR BERETTA
APX

Reference nr.

ET-241150

NEW



EEMANN TECH TRIGGER SAFETY SPRING FOR
BERETTA APX

Reference nr.

ET-241151

NEW



EEMANN TECH MAGAZINE CATCH SPRING FOR
BERETTA APX

Reference nr.

ET-241145

NEW



Eemann Tech Competition Trigger Springs Kit for AR-15



Customize your **trigger**



EEMANN TECH COMPETITION TRIGGER SPRINGS KIT FOR AR-15

Reference nr.

ET-180001



EEMANN TECH TACTICAL TRIGGER SPRINGS KIT FOR AR-15

Reference nr.

ET-180002



EEMANN TECH AR-15 LOWER SMALL PARTS SET

Reference nr.

ET-180005



EEMANN TECH SMALL SPRINGS SET FOR AR-15

Reference nr.

ET-180030

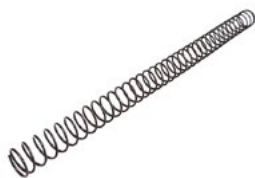

EEMANN TECH RECOIL BUFFER SPRING FOR AR-15

Reference nr.

ET-180006

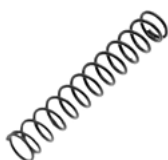

EEMANN TECH AR-15 RECOIL BUFFER RETAINER SPRING

Reference nr.

ET-180011



EEMANN TECH COMPETITION BUFFER SPRING FOR AR-15 PLATFORM

Reference nr.	Spring weight	
ET-180208	8 lbs	NEW
ET-180210	10 lbs	NEW
ET-180212	12 lbs	NEW
ET-180216	16 lbs	NEW



EEMANN TECH COMPETITION BUFFER SPRING CALIBRATION PACK FOR AR-15 PLATFORM

Reference nr.	Spring weight	Color	
ET-180240			NEW
↳ ET-180208	8 lbs	Yellow	
↳ ET-180210	10 lbs	Blue	
↳ ET-180212	12 lbs	Red	
↳ ET-180216	16 lbs	Orange	



EEMANN TECH AR-15 MAGAZINE RELEASE SPRING**Reference nr.**

ET-180012



EEMANN TECH AR-15 TAKEDOWN DETENT SPRING**Reference nr.**

ET-180013



EEMANN TECH AR-15 SELECTOR DETENT SPRING**Reference nr.**

ET-180014



EEMANN TECH AR-15 PIVOT DETENT SPRING

Reference nr.

ET-180015



EEMANN TECH AR-15 BOLT CATCH DETENT SPRING

Reference nr.

ET-180016



EEMANN TECH DISCONNECTOR SPRING FOR AR-15

Reference nr.

ET-180071



EEMANN TECH EXTRACTOR SPRING FOR AR-15

Reference nr.

ET-180056



EEMANN TECH EJECTOR SPRING FOR AR-15

Reference nr.

ET-180052



EEMANN TECH CHARGING HANDLE LATCH SPRING FOR AR-15, AR-9

Reference nr.

ET-180091



EEMANN TECH COMPETITION TRIGGER SPRING FOR AR-15

Reference nr.

ET-180003



EEMANN TECH HAMMER SPRING FOR AR-15

Reference nr.

ET-180075



EEMANN TECH COMPETITION HAMMER SPRING FOR AR-15

Reference nr.

ET-180078

AR-9 PCC



EEMANN TECH FIRING PIN SPRING FOR AR-9 PCC

Reference nr.

ET-189003



EEMANN TECH SPRINGS KIT FOR MOLOT-VEPR 12GA

Reference nr.

ET-170012

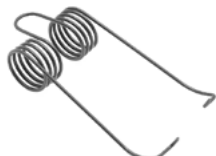

EEMANN TECH HAMMER SPRING FOR MOLOT-VEPR 12GA

Reference nr.

ET-170554



EEMANN TECH EXTRACTOR SPRING FOR MOLOT-VEPR 12GA

Reference nr.

ET-170060



EEMANN TECH FIRING PIN SPRING FOR MOLOT-VEPR 12GA

Reference nr.

ET-170061



EEMANN TECH MAGAZINE CATCH SPRING FOR MOLOT-VEPR 12GA

Reference nr.

ET-170474



EEMANN TECH SLIDE LOCK SPRING FOR MOLOT-VEPR 12GA

Reference nr.

ET-170388

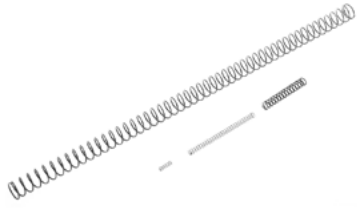

EEMANN TECH COMPETITION SPRINGS KIT FOR BENELLI

Reference nr.

ET-191001



EEMANN TECH RECOIL SPRING FOR BENELLI

Reference nr.

ET-191005

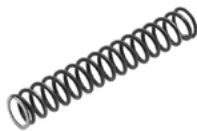

EEMANN TECH HAMMER SPRING FOR BENELLI

Reference nr.

ET-191002



EEMANN TECH TRIGGER SPRING FOR BENELLI

Reference nr.

ET-191003

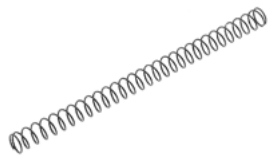

EEMANN TECH FIRING PIN SPRING FOR BENELLI

Reference nr.

ET-191004



EEMANN TECH SHOTGUN EXTENSION TUBE SPRING FOR 12GA

Reference nr.

ET-121212



GRAND POWER LTD. SLOVAKIA
MODEL 1911
CALIBER .38 S&W
SERIAL NO. 11111111111111111111
MADE IN SLOVAKIA



EEMANN TECH RECOIL SPRING FOR GRAND POWER T10 / T12 / T910

Reference nr.

ET-190001

The Eemann Tech recoil spring for traumatic pistols GRAND POWER T10, T12, and T910 consists of two springs with different powers. Use both springs together if you want to achieve the most power. They can also be used separately for a lower power outcome.

Outer spring:

Diameter (OD): 10.1 mm

Length: 91.4 mm

Inner spring:

Diameter (OD): 8.2 mm

Length: 88.3 mm

Material: Steel**Color:** Black



EEMANN TECH AUTOSAFETY SPRING FOR GRAND POWER K100

Reference nr.

ET-190003



EEMANN TECH EXTRACTOR SPRING FOR GRAND POWER K100

Reference nr.

ET-190046



EEMANN TECH TRIGGER SPRING FOR GRAND POWER K100

Reference nr.

ET-190033



EEMANN TECH HAMMER CATCH SPRING FOR GRAND POWER K100

Reference nr.

ET-190026



EEMANN TECH AUTOSAFETY SPRING FOR GRAND POWER K100

Reference nr.

ET-190003



STRIBOG RSR943



9x19 CP 22.1

9x19 CP 22.1

GRAND POWER
Made in Slovakia



EEMANN TECH SPARE SPRINGS KIT FOR GRAND POWER STRIBOG

Reference nr.

ET-190101

- ↳ ET-190130
- ↳ ET-190132
- ↳ ET-190133
- ↳ ET-190139
- ↳ ET-190143
- ↳ ET-190148
- ↳ ET-190153
- ↳ ET-190154
- ↳ ET-190157
- ↳ ET-190161



EEMANN TECH RECOIL SPRING FOR GRAND POWER STRIBOG SP9 A3

Reference nr.

ET-190148



EEMANN TECH COMPETITION TRIGGER SPRINGS KIT FOR GRAND POWER STRIBOG

Reference nr.

ET-190970



EEMANN TECH DISCONNECTOR SPRING FOR GRAND POWER STRIBOG

Reference nr.

ET-190132



EEMANN TECH BOLT CATCH SPRING FOR GRAND POWER STRIBOG

Reference nr.

ET-190139



EEMANN TECH FRONT TAKEDOWN PIN SPRING
FOR GRAND POWER STRIBOG

Reference nr.

ET-190154



EEMANN TECH MAGAZINE RELEASE SPRING FOR
GRAND POWER STRIBOG

Reference nr.

ET-190143



EEMANN TECH EXTRACTOR SPRING FOR GRAND
POWER STRIBOG

Reference nr.

ET-190153



EEMANN TECH FIRING PIN SPRING FOR GRAND
POWER STRIBOG

Reference nr.

ET-190161



EEMANN TECH SIGHT SPRING FOR GRAND
POWER STRIBOG

Reference nr.

ET-190157



EEMANN TECH HAMMER SPRING FOR GRAND
POWER STRIBOG

Reference nr.

ET-190133



EEMANN TECH TRIGGER SPRING FOR GRAND
POWER STRIBOG

Reference nr.

ET-190130



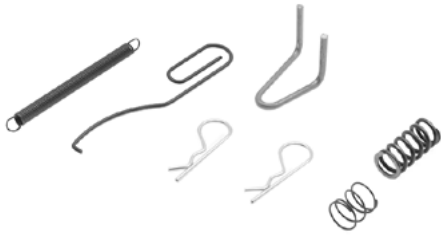

EEMANN TECH SPRINGS KIT FOR DILLON RL550

Reference nr.

ET-520048



EEMANN TECH EJECTOR WIRE 13925 FOR DILLON RL550

Reference nr.

ET-513925



EEMANN TECH PRIMER CUP SPRING 14033 FOR DILLON XL550/XL650

Reference nr.

ET-514033



EEMANN TECH SLIDE RETURN SPRING 13928 FOR DILLON RL550

Reference nr.

ET-513928



EEMANN TECH CARTRIDGE SPRING 13926 FOR DILLON RL550

Reference nr.

ET-513926



EEMANN TECH LOCATOR TAB SPRING 13624 FOR DILLON XL650

Reference nr.

ET-513624



EEMANN TECH DISC DETENT SPRING 13844 FOR DILLON XL650

Reference nr.

ET-513844



EEMANN TECH INDEXING ARM SPRING 13965 FOR DILLON XL650

Reference nr.

ET-513965



EEMANN TECH SPRINGS KIT FOR DILLON XL650/XL750

Reference nr.

ET-521146



EEMANN TECH PAWL SPRING 13938 FOR DILLON XL650/XL750

Reference nr.

ET-513938



EEMANN TECH INDEX BALL SPRING 13997 FOR
DILLON XL650/XL750

Reference nr.

ET-513997



EEMANN TECH CASE INSERT SLIDE SPRING 13937
FOR DILLON XL650/XL750

Reference nr.

ET-513937



EEMANN TECH CASEFEED ARM RETURN SPRING
13936 FOR DILLON XL650/XL750

Reference nr.

ET-513936



EEMANN TECH EJECTOR WIRE 13298 FOR
DILLON XL650/XL750

Reference nr.

ET-513298



EEMANN TECH INDEXER RETURN SPRING
13791 FOR DILLON XL650/XL750

Reference nr.

ET-513791



EEMANN TECH SPRINGS KIT 75111 FOR
DILLON XL750

Reference nr.

ET-575111



EEMANN TECH PRIMER PUNCH SPRING
62328 FOR DILLON XL750

Reference nr.

ET-562328



EEMANN TECH STATION 2 LOCATOR SPRING
62331 FOR DILLON XL750

Reference nr.

ET-562331



EEMANN TECH PRIMER PUNCH SPRING
13858 FOR DILLON 1050

Reference nr.

ET-513858



EEMANN TECH SPRINGS KIT FOR DILLON RL1050

Reference nr.

ET-501050



EEMANN TECH TOOLHEAD SPRING 8,5\"/> A12572 FOR DILLON RL1050*

Reference nr.

ET-512572

*For Dillon RL1050 machines produced before January 2016 (older models)



EEMANN TECH TOOLHEAD SPRING 10,5\"/> 12572 FOR DILLON RL1050*

Reference nr.

ET-512570

*For Dillon RL1050 machines produced after January 2016 (modern models)



EEMANN TECH INDEXER RETURN SPRING FOR DILLON 1050, SQUAREB

Reference nr.

ET-513944



EEMANN TECH INDEX BALL SPRING FOR RL1100 /
SUPER 1050

Reference nr.

ET-513525

NEW



EEMANN TECH CASE INSERT PLUNGER SPRING
FOR DILLON RL1050/RL1100

Reference nr.

ET-513567

NEW



EEMANN TECH PRIMER STATION LOCATOR
SPRING FOR DILLON RL1100

Reference nr.

ET-566216



EEMANN TECH DECAPPING PINS 1,3MM FOR NON
TOX CASES - 20 PCS./PACK

Reference nr.

ET-513754

NEW



EEMANN TECH DECAPPING PINS 10 PCS. PACK
FOR DILLON DIES

Reference nr.

ET-513753



Eemann Tech Decapping Pins 1,3mm for
Non Tox Cases - 20 pcs./pack





EEMANN TECH RETAINING CLIPS 10-PACK FOR
DILLON 14040 PICKUP TUBE

Reference nr.

ET-514040



EEMANN TECH POWDER MEASURE RETURN
SPRINGS SET FOR DILLON

Reference nr.

ET-512001





EEMANN TECH SPRINGS KIT FOR PHOENIX REDBACK

Reference nr.

ET-169000

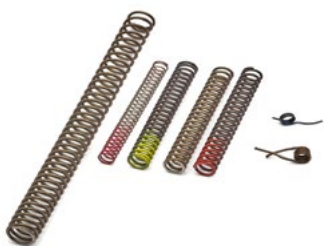

EEMANN TECH COMPETITION SPRINGS KIT FOR PHOENIX

Reference nr.

ET-169020

- ↳ ET-169005
- ↳ ET-169011
- ↳ ET-169013
- ↳ ET-169019
- ↳ ET-169018
- ↳ ET-169017
- ↳ ET-169016



EEMANN TECH RECOIL SPRING FOR PHOENIX REDBACK

Reference nr.

Spring weight

ET-169003 13 lbs

ET-169004 12 lbs

ET-169005 11 lbs

ET-169006 10 lbs



EEMANN TECH MAIN SPRING FOR PHOENIX REDBACK

Reference nr.

Spring weight

ET-169014 10 lbs

ET-169015 9 lbs

ET-169016 8 lbs



EEMANN TECH FIRING PIN SPRING FOR PHOENIX REDBACK

Reference nr.

ET-169001



EEMANN TECH SEAR SPRING FOR PHOENIX REDBACK

Reference nr.

ET-169012



EEMANN TECH COMPETITION SEAR SPRING (-10% POWER) FOR PHOENIX REDBACK

Reference nr.

ET-169013



EEMANN TECH TRIGGER SPRING FOR PHOENIX REDBACK

Reference nr.

ET-169010



EEMANN TECH COMPETITION TRIGGER SPRING FOR PHOENIX REDBACK

Reference nr.

ET-169011



EEMANN TECH COMPETITION FIRING PIN SPRING
FOR PHOENIX

Reference nr.

ET-169019

NEW



EEMANN TECH EXTRACTOR SPRING FOR PHOENIX

Reference nr.

ET-169023



EEMANN TECH MAGAZINE CATCH SPRING LIGHT
FOR PHOENIX

Reference nr.

ET-169022



EEMANN TECH SAFETY PLUNGER SPRING LIGHT
FOR PHOENIX

Reference nr.

ET-169025



EEMANN TECH SAFETY LEVER SPRING FOR
PHOENIX

Reference nr.

ET-169030

NEW



EEMANN TECH MAGAZINE RELEASE SPRING FOR PHOENIX

Reference nr.

ET-169031

NEW



EEMANN TECH TRIGGER BAR SPRING FOR PHOENIX

Reference nr.

ET-169021



EEMANN TECH COMPETITION TRIGGER BAR SPRING FOR PHOENIX

Reference nr.

ET-169024



EEMANN TECH SLIDE RELEASE SPRING FOR PHOENIX

Reference nr.

ET-169032

NEW



EEMANN TECH CONNECTING LEVER SPRING FOR BERETTA APX

Reference nr.

ET-241147

NEW





EEMANN TECH MAGAZINE SPRING +2
FOR WALTHER PPQ, P99, Q5 MATCH SF

Reference nr.

ET-249508



EEMANN TECH TRIGGER SPRING
FOR WALTHER PPQ/PDP

Reference nr.

ET-249001



EEMANN TECH COMPETITION TRIGGER SPRING
FOR WALTHER PPQ/PDP

Reference nr.

ET-249002



EEMANN TECH SAFETY PLUNGER SPRING
FOR WALTHER PDP/Q-SERIES

Reference nr.

ET-249095



EEMANN TECH EXTRACTOR SPRING
FOR WALTHER P99/PPQ

Reference nr.

ET-249014



EEMANN TECH SLIDE STOP LEVER SPRING
FOR WALTHER Q5 MATCH SF

Reference nr.

ET-249051



KIMB

9x19

DP21002

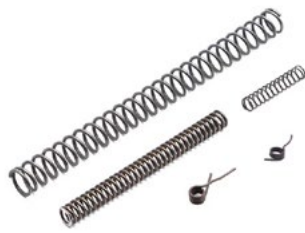

EEMANN TECH COMPETITION SPRINGS KIT FOR KMR 4.5"

Reference nr.

ET-134704

Eemann Tech Competition Springs Kit ET-134704 for KMR 4.5" contains:

- ET-134725 Eemann Tech Recoil Spring for KMR 4.5" 12lbs - 1pc.
- ET-134708 Eemann Tech Main Spring for KMR 8lbs - 1pc.
- ET-134700 Eemann Tech Competition Trigger Spring for KMR - 1pc.
- ET-134703 Eemann Tech Competition Firing Pin Spring for KMR - 1pc.
- ET-134701 Eemann Tech Competition Sear Spring for KMR - 1pc.

Compatible with:

- KMR L-02 4.5" and their models
- KMR W-02 4.5" and their models



EEMANN TECH COMPETITION SPRINGS KIT FOR KMR 5"

Reference nr.

ET-134705

Eemann Tech Competition Springs Kit ET-134705 for KMR 5" contains:

- ET-134717 Eemann Tech Recoil Spring for KMR 5" 12lbs - 1pc.
- ET-134708 Eemann Tech Main Spring for KMR 8lbs - 1pc.
- ET-134700 Eemann Tech Competition Trigger Spring for KMR - 1pc.
- ET-134703 Eemann Tech Competition Firing Pin Spring for KMR - 1pc.
- ET-134701 Eemann Tech Competition Sear Spring for KMR - 1pc.

Compatible with:

- KMR L-02 5" and their models
- KMR W-02 5" and their models



EEMANN TECH RECOIL SPRING FOR KMR SPECTRA 5"

Reference nr.	Spring weight
---------------	---------------

ET-134712	7 lbs
-----------	-------

ET-134713	8 lbs
-----------	-------

ET-134714	9 lbs
-----------	-------

ET-134715	10 lbs
-----------	--------

ET-134716	11 lbs
-----------	--------

ET-134717	12 lbs
-----------	--------

ET-134718	13 lbs
-----------	--------



EEMANN TECH RECOIL SPRING FOR KMR UMBRA 4,5"

Reference nr.	Spring weight
---------------	---------------

ET-134723	8 lbs
-----------	-------

ET-134724	10 lbs
-----------	--------

ET-134725	12 lbs
-----------	--------

ET-134726	14 lbs
-----------	--------

ET-134727	16 lbs
-----------	--------



EEMANN TECH MAIN SPRING FOR KMR

Reference nr.	Spring weight
---------------	---------------

ET-134707	7 lbs
-----------	-------

ET-134708	8 lbs
-----------	-------

ET-134709	9 lbs
-----------	-------

ET-134710	10 lbs
-----------	--------



EEMANN TECH EXTRACTOR SPRING FOR KMR

Reference nr.

ET-134711



EEMANN TECH COMPETITION TRIGGER SPRING FOR KMR

Reference nr.

ET-134700



EEMANN TECH COMPETITION SEAR SPRING FOR KMR

Reference nr.

ET-134701



EEMANN TECH COMPETITION FIRING PIN SPRING FOR KMR

Reference nr.

ET-134703





EEMANN TECH SPRINGS SET FOR UPLULA SPEEDLOADER

Reference nr.

ET-040015

S.P.S



EEMANN TECH MAIN SPRING FOR SPS

Reference nr.

Spring weight

ET-111165

13 lbs

ET-111166*

16 lbs

*Factory power

ARMA ZEKA



EEMANN TECH RECOIL SPRING FOR ARMA ZEKA

Reference nr.

Spring weight

ET-172413

13 lbs

ET-172414

14 lbs

ET-172415

15 lbs

ET-172416

16 lbs

ET-172417

17 lbs

ET-172418

18 lbs

JP5 PCC



EEMANN TECH EXTRACTOR SPRING FOR JP5 / H&K MP5

Reference nr.

ET-185401

NEW

MARK7 APEX10



EEMANN TECH REPLACEMENT SPRINGS KIT FOR APEX10 RELOADING PRESS

Reference nr.

ET-591178

NEW

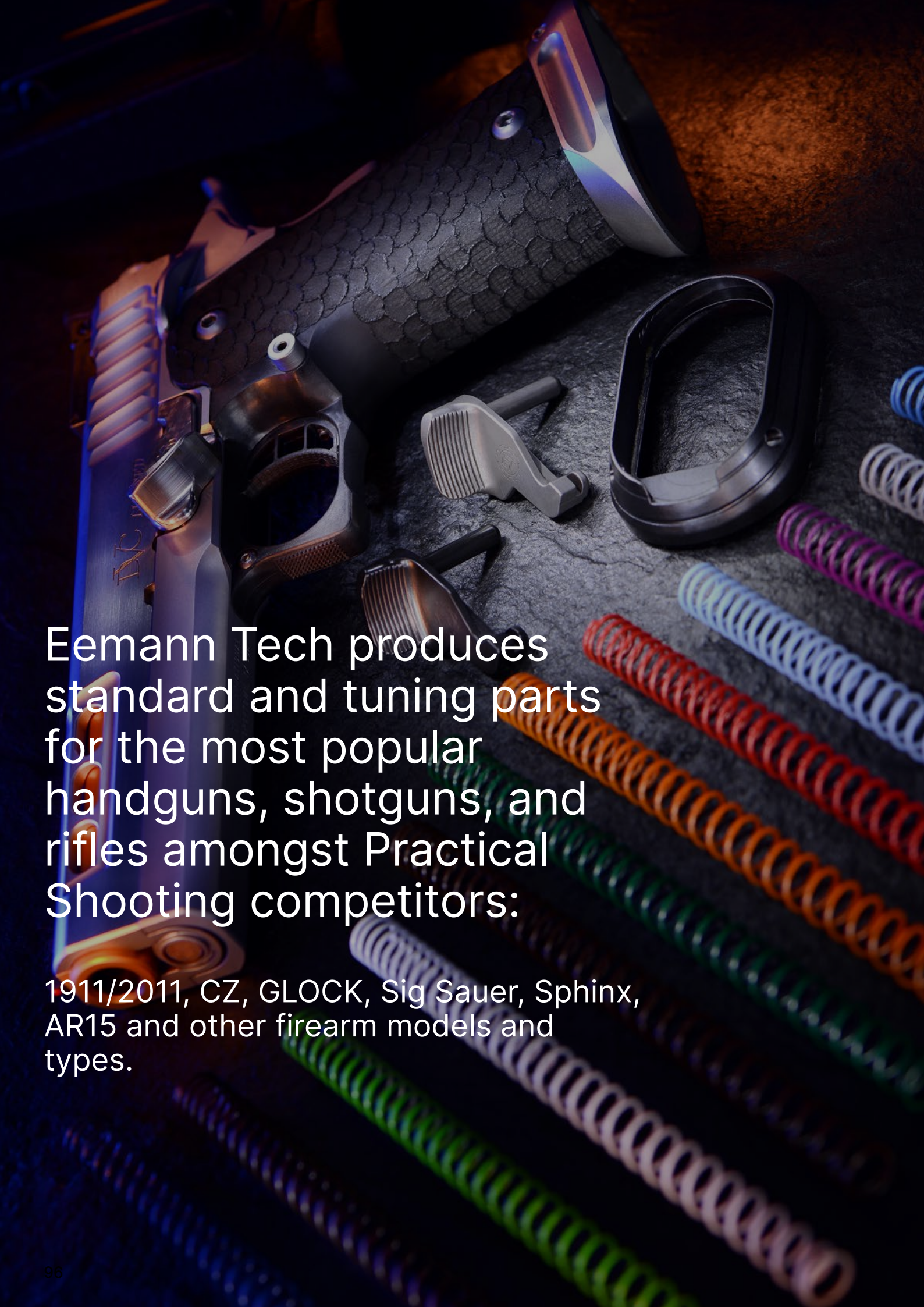
A collection of firearm parts is displayed on a dark, textured surface. In the foreground, several coiled springs in various colors (blue, red, orange, green, purple, white) are arranged diagonally. To the left, a portion of a handgun slide is visible, showing the 'EEMANN' logo. In the center, there is a magazine and a slide. To the right, a magazine is shown without its follower. The lighting is dramatic, highlighting the metallic and plastic components against the dark background.

Eemann Tech produces standard and tuning parts for the most popular handguns, shotguns, and rifles amongst Practical Shooting competitors:

1911/2011, CZ, GLOCK, Sig Sauer, Sphinx, AR15 and other firearm models and types.

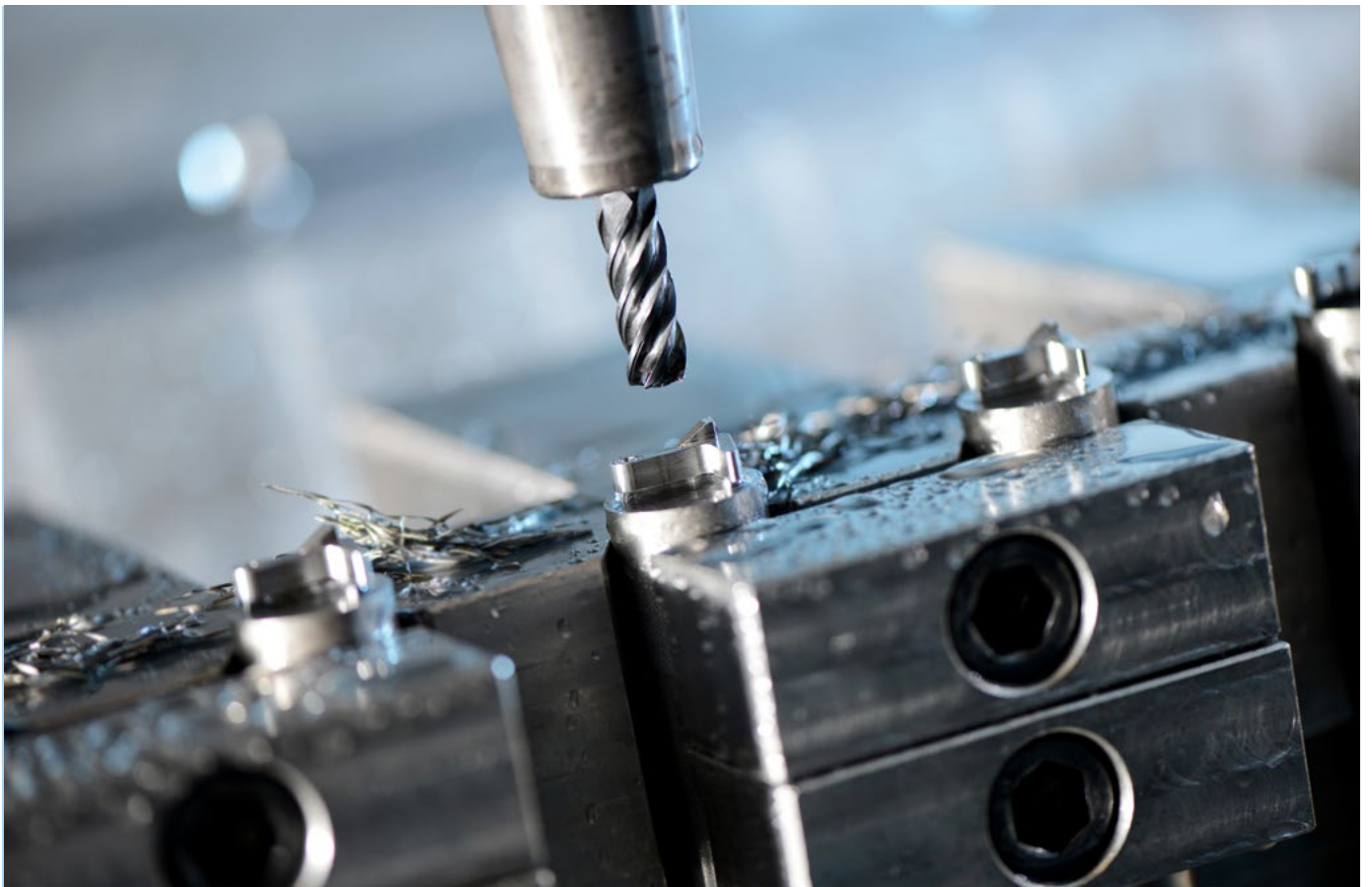

We make spare parts of excellent quality, exceeding the quality of factory-made standard parts.

We pay special attention to the tuning parts. While developing parts we use the long-term experience of the best Practical Shooting competitors around the world. All parts are made of high quality materials using modern and advanced technology.

Every competitor is able to customize their shooting equipment using the Eemann Tech parts according to their needs and division. We have everything for making handguns meet the factory parameters using Eemann Tech classic-line spare parts or make them highly customized by using the Eemann Tech

tuning-line parts.

We produce trigger mechanisms, enhanced slide stops and thumb safeties; sport extended magazine catches, front and rear sights; main, trigger, sear and recoil springs, recoil spring guide rods and many other parts that are needed and wanted among the competitive shooters all over the world.

All parts are labeled and packed accordingly.

GUN PARTS

All Eemann Tech parts are fully CNC-machined (MIM FREE).

EEMANN TECH SLIDE STOP WITH THUMB REST FOR 1911/2011

Reference nr.	Color
ET-111295	Black
ET-111296	Silver

Eemann Tech Slide Stop with Thumb Rest is made from one piece of carbon steel and CNC machined to the highest standards.

It is designed to be used with 1911/2011 firearms and their clones.

Advantages:

- No firearm modification required
- No fitting required and instant installation
- Provides stability and consistent grip for recoil control
- Slide stop thumb rest functions as a normal slide stop allowing slide to lock back if required
- When installed, fits in the IPSC Standard gun box
- Legal in IPSC Standard and Open divisions, Fits in IPSC Standard Box

Total width: ~37,5mm (1,475")

Thumb rest width: ~12,95mm (~0,5")

Weight: ~22 g





EEMANN TECH SLIDE STOP WITH THUMB REST FOR 1911/2011

Reference nr.	Color
ET-211293	Black
ET-212292	Silver

Eemann Tech Thumb Rest Slide Stop For Colt 1911, 2011 and clones.

Material: Stainless Steel

Caliber: All

All the EEMANN TECH parts for Colt 1911, STI 2011 and their clones are made from high quality carbon, alloyed or stainless steel using technologies and CNC machines of new generation.



Eemann Tech Ultimate Aluminium Long Grips for 1911

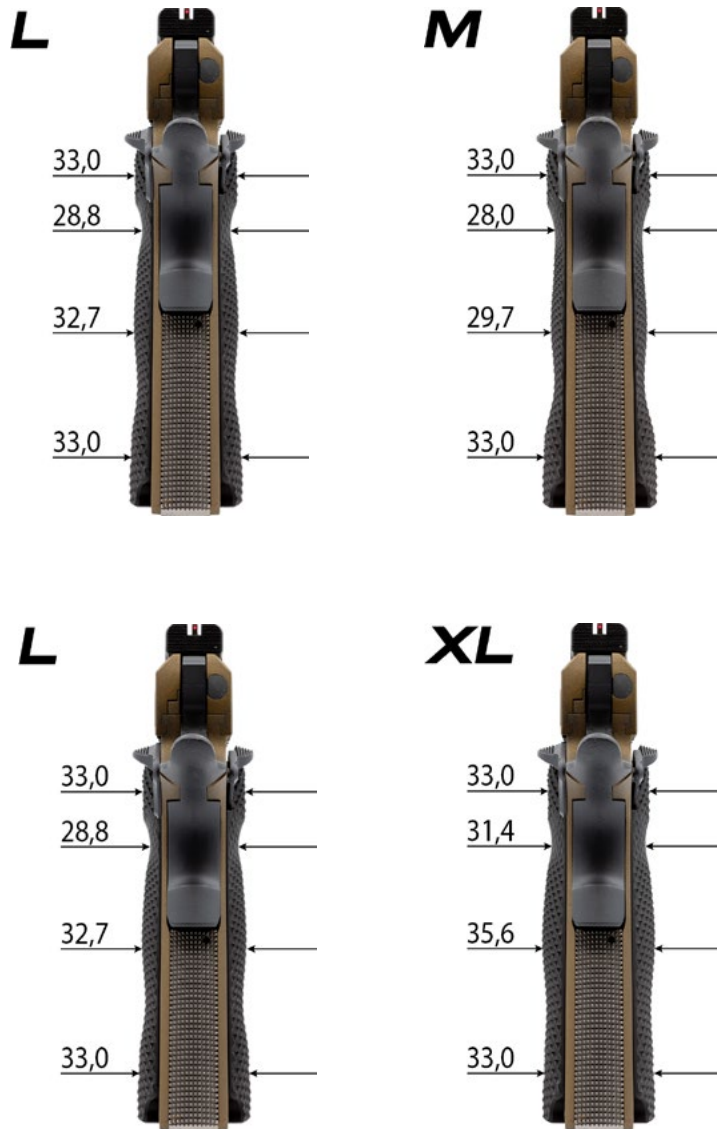

Crafted from high-quality aluminum, the Eemann Tech Ultimate Aluminium Long Grips for 1911 and their clones offer exceptional durability and a balanced, weighted feel for superior handling and control.

Material: Aluminium

Set contains:

- 1 x Aluminium Long Grip Left
- 1 x Aluminium Long Grip Right

Available sizes:

- Small - thickness: 3,9 mm
- Medium - thickness: 5,3 mm
- Large - thickness: 6,7 mm
- Extra Large - thickness: 8,26 mm

Weight:

- Small - 50 gr (1 pc) / 100 gr (2 pcs)
- Medium - 57 gr (1 pc) / 114 gr (2 pcs)
- Large - 63 gr (1 pc) / 126 gr (2 pcs)
- Extra Large - 70 gr (1 pc) / 140 gr (2 pcs)

Eemann Tech Ultimate Brass Long Grips for 1911



The Eemann Tech Ultimate Brass Long Grips are precision-engineered for 1911 pistols, constructed from high-quality brass to deliver enhanced control and stability through added weight.

Material: Premium Brass

Set contains:

- 1 x Brass Long Grip Left
- 1 x Brass Long Grip Right

Available sizes:

- Small - thickness: 3,9 mm
- Medium - thickness: 5,3 mm
- Large - thickness: 6,7 mm
- Extra Large - thickness: 8,26 mm

Weight:

- Small - 100 gr (1 pc) / 200 gr (2 pcs)
- Medium - 113 gr (1 pc) / 226 gr (2 pcs)
- Large - 126 gr (1 pc) / 252 gr (2 pcs)
- Extra Large - 140 gr (1 pc) / 280 gr (2 pcs)



EEMANN TECH ULTIMATE ALUMINIUM LONG GRIPS FOR 1911

Reference nr.	Size
ET-111536	S
ET-111537	M
ET-111538	L
ET-111539	XL



EEMANN TECH ULTIMATE BRASS LONG GRIPS FOR 1911

Reference nr.	Size
ET-111531	S
ET-111532	M
ET-111533	L
ET-111534	XL







EEMANN TECH TRIGGER FOR 1911

Reference nr.	Color
ET-111140	Black
ET-111143	Silver

Trigger full length: 56,5mm



EEMANN TECH K-HOLE TRIGGER FOR 1911

Reference nr.	Color
ET-111141	Black
ET-111142	Silver

Trigger full length: 56,7mm



EEMANN TECH SOLID TRIGGER FOR 2011

Reference nr.	Color
ET-111145	Silver

Trigger full length: 51,2mm



EEMANN TECH TRIGGER FOR 2011

Reference nr.	Color
ET-111196	Black
ET-111197	Silver

Trigger full length: 56,5mm



EEMANN TECH SOLID TRIGGER LONG FOR 2011

Reference nr.	Color
ET-111147	Silver

Trigger full length: 56,6mm



EEMANN TECH K-HOLE FLAT TRIGGER FOR 2011

Reference nr.	Color
ET-111148	Black
ET-111149	Silver

Trigger full length: 57,8mm



EEMANN TECH K-HOLE TRIGGER FOR 2011

Reference nr.	Color
ET-111198	Black
ET-111199	Silver

Trigger full length: 56,7mm





Eemann Tech Front Sight for 1911/2011, Checked With 1mm Fiber Optics Rod

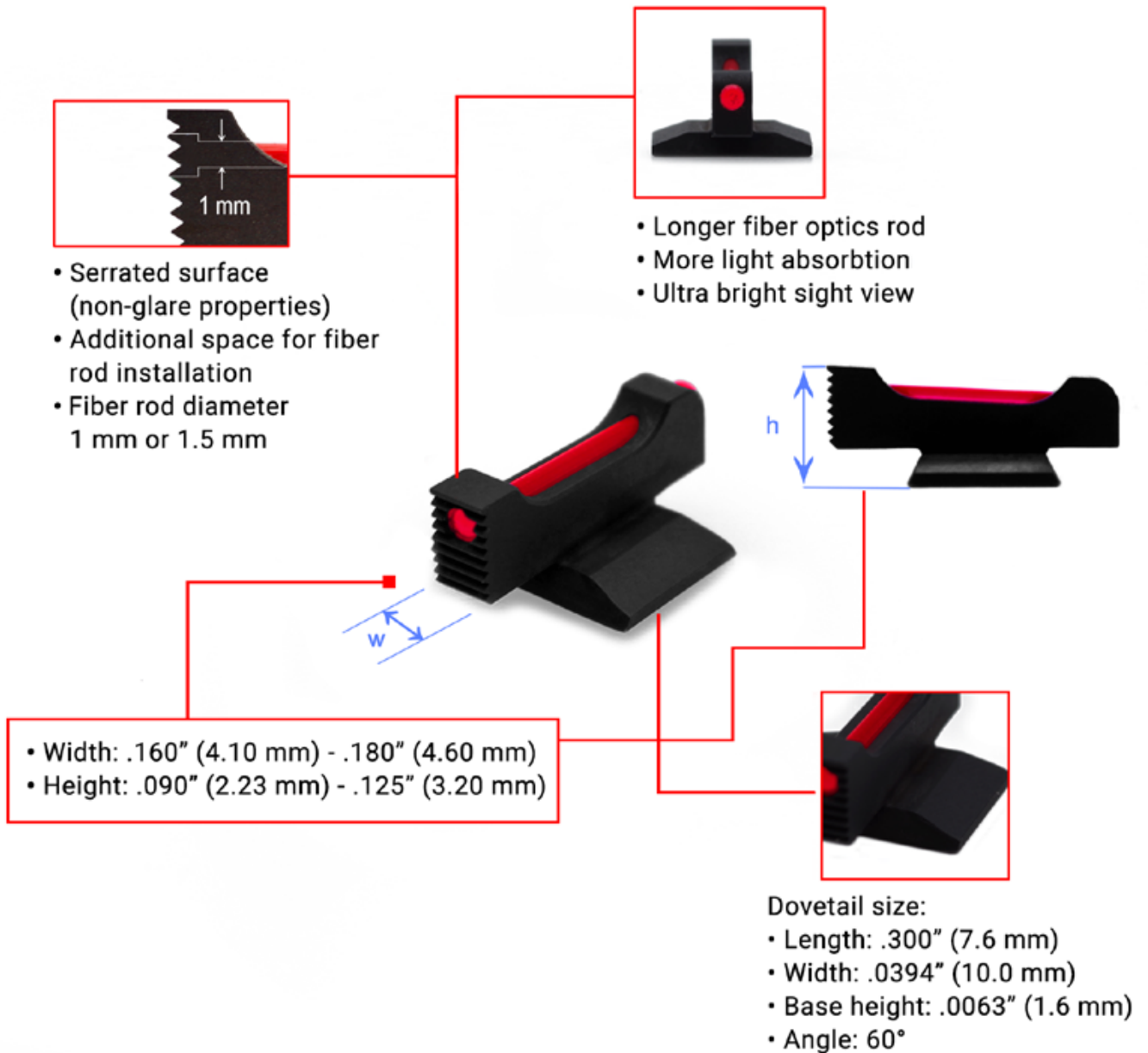

Perfection in every detail



EEMANN TECH FRONT SIGHT FOR 1911/2011,
CHECKERED, STEEL

Reference nr.	Height	Width
ET-130400	.180" (4.60mm)	.125" (3.20mm)
ET-130401	.180" (4.60mm)	.110" (2.80mm)
ET-130402	.180" (4.60mm)	.100" (2.56mm)
ET-130403	.180" (4.60mm)	.090" (2.23mm)
ET-130404	.160" (4.10mm)	.125" (3.20mm)
ET-130405	.160" (4.10mm)	.110" (2.80mm)
ET-130406	.160" (4.10mm)	.100" (2.56mm)
ET-130407	.160" (4.10mm)	.090" (2.23mm)



EEMANN TECH FRONT SIGHT FOR 1911/2011,
CHECKERED WITH 1MM FIBER OPTICS ROD

Reference nr.	Height	Width
ET-130408	.180" (4.60mm)	.125" (3.20mm)
ET-130409	.180" (4.60mm)	.110" (2.80mm)
ET-130410	.180" (4.60mm)	.100" (2.56mm)
ET-130411	.180" (4.60mm)	.090" (2.23mm)
ET-130412	.160" (4.10mm)	.125" (3.20mm)
ET-130413	.160" (4.10mm)	.110" (2.80mm)
ET-130414	.160" (4.10mm)	.100" (2.56mm)
ET-130415	.160" (4.10mm)	.090" (2.23mm)



EEMANN TECH FRONT SIGHT FOR 1911/2011,
CHECKERED WITH 1,5MM FIBER OPTICS ROD

Reference nr.	Height	Width
ET-130416	.180" (4.60mm)	.125" (3.20mm)
ET-130417	.180" (4.60mm)	.110" (2.80mm)
ET-130418	.180" (4.60mm)	.100" (2.56mm)
ET-130419	.160" (4.10mm)	.125" (3.20mm)
ET-130420	.160" (4.10mm)	.110" (2.80mm)
ET-130421	.160" (4.10mm)	.100" (2.56mm)



EEMANN TECH ADJUSTABLE REAR SIGHT BOMAR
FOR 1911/2011

Reference nr.
ET-111600



115

TX 00431

20M

115

MORE

11501

11902

OST



EEMANN TECH ALUMINIUM RED DOT MOUNT FOR 1911/2011 BOMAR CUT

Reference nr.

ET-111901

NEW

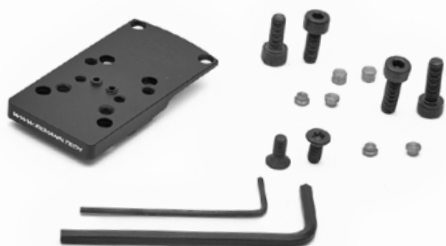

EEMANN TECH ALUMINIUM RED DOT MOUNT FOR 1911/2011 BOMAR CUT

Reference nr.

ET-111902

NEW



EEMANN TECH ALUMINIUM RED DOT MOUNT FOR 1911/2011 LPA TRT CUT

Reference nr.

ET-111903

NEW



EEMANN TECH ALUMINIUM RED DOT MOUNT FOR 1911/2011 BOMAR CUT

Reference nr.

ET-111904

NEW





Eemann Tech Extended Firing Pin for 1911/2011

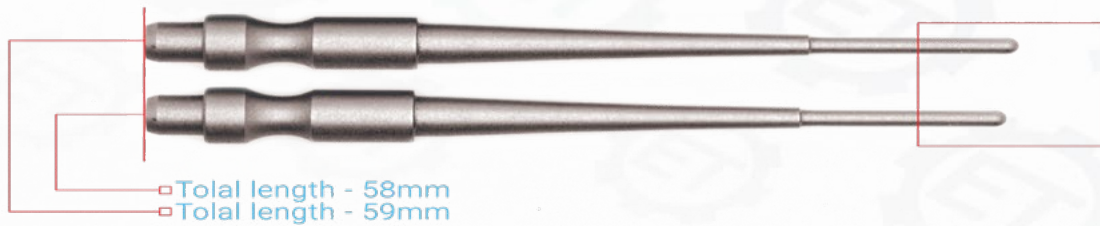

Control your speed



EEMANN TECH FIRING PIN FOR 1911/2011

Reference nr.	Caliber	Color
ET-112050	9mm/.38S/.40S&W	Silver



EEMANN TECH EXTENDED FIRING PIN FOR 1911/2011

Reference nr.	Caliber	Color
ET-112052	9mm/.38S/.40S&W	Silver



EEMANN TECH PINS SET FOR 2011

Reference nr.	Color
ET-111603	Black
ET-111604	Silver



EEMANN TECH PINS SET FOR 1911

Reference nr.	Color
ET-111601	Black
ET-111602	Silver



EEMANN TECH MAINSPRING HOUSING PIN FOR 2011

Reference nr.	Color
ET-212220	Silver
ET-211220	Black



EEMANN TECH MAINSPRING HOUSING PIN FOR 1911

Reference nr.	Color
ET-111220	Black
ET-112220	Silver



EEMANN TECH MAINSPRING HOUSING PIN RETAINER FOR 1911/2011

Reference nr.	Color
ET-111170	Black
ET-112170	Silver



EEMANN TECH MAINSPRING CAP FOR 1911/2011

Reference nr.	Color
ET-111150	Black
ET-112150	Silver



EEMANN TECH MAINSPRING CAP PIN FOR 1911/2011

Reference nr.	Color
ET-111190	Black
ET-112190	Silver



EEMANN TECH EJECTOR PIN FOR 1911/2011

Reference nr.	Color
ET-111460	Black
ET-112460	Silver

Diameter: 0,05" (1,5mm)



EEMANN TECH HAMMER PIN FOR 1911/2011

Reference nr.	Color
ET-111270	Black
ET-112270	Silver



EEMANN TECH HAMMER STRUT PIN FOR 1911/2011

Reference nr.	Color
ET-111420	Black
ET-112420	Silver



EEMANN TECH BARREL LINK PIN FOR 1911/2011

Reference nr.	Color
ET-111360	Black
ET-112360	Silver



EEMANN TECH SEAR PIN FOR 1911/2011

Reference nr.	Color
ET-111280	Black
ET-112280	Silver



EEMANN TECH COMPETITION EXTRACTOR FOR 1911/2011

Reference nr.	Caliber	Color
ET-111034	9mm/.40S&W	Black



SPARE SPRING CAP FOR EEMANN TECH COMPETITION EXTRACTOR 1911/2011

Reference nr.
ET-111035



EEMANN TECH EXTRACTOR FOR 1911/2011

Reference nr.	Caliber	Color
ET-111030	9mm/.40S&W	Black
ET-111031	.45auto	Black
ET-111032	.45auto 80 Series	Black



EEMANN TECH MAGAZINE CATCH PLAIN FOR 1911*

Reference nr.	Color
ET-111090	Black
ET-111091	Silver

*Catch lock and catch spring not included



EEMANN TECH MAGAZINE CATCH WITH EXTENDED BUTTON FOR 1911*

Reference nr.	Color
ET-111092	Black
ET-111093	Silver

*Catch lock and catch spring not included



EEMANN TECH MAGAZINE CATCH PLAIN FOR 2011*

Reference nr.	Color
ET-111094	Black
ET-111095	Silver

*Catch lock and catch spring not included



EEMANN TECH MAGAZINE CATCH WITH EXTENDED BUTTON FOR 2011*

Reference nr.	Color
ET-111096	Black
ET-111097	Silver

*Catch lock and catch spring not included



EEMANN TECH MAGAZINE CATCH LOCK FOR 1911/2011

Reference nr.	Color
ET-111070	Black
ET-111071	Silver



EEMANN TECH EXTENDED SLIDE STOP FOR 1911*

Reference nr.	Color
ET-211291	Black

* For calibers 9×19mm, .45



EEMANN TECH SOLID SLIDE STOP FOR 1911/2011*

Reference nr.	Color
ET-211290	Black
ET-212290	Silver

* For calibers 9×19mm, .40S&W, .45



EEMANN TECH SLIDE STOP PLUNGER FOR 1911/2011

Reference nr.	Color
ET-111100	Black
ET-112100	Silver



EEMANN TECH SAFETY LOCK PLUNGER FOR 1911/2011

Reference nr.	Color
ET-111120	Black
ET-112120	Silver



EEMANN TECH PLUNGER TUBE FOR 1911/2011

Reference nr.	Color
ET-111440	Black



EEMANN TECH SOLID SAFETY FOR 1911/2011

Reference nr.	Color
ET-111260	Black
ET-111261	Silver



EEMANN TECH SOLID COMBAT SINGLE SAFETY FOR 1911

Reference nr.	Color
ET-111262	Black
ET-111263	Silver



EEMANN TECH BEAVERTAIL GRIP SAFETY FOR 1911/2011

Reference nr.	Color
ET-111173	Black
ET-111174	Silver



EEMANN TECH SOLID WIDE SINGLE SAFETY FOR 1911

Reference nr.	Color
ET-111264	Black
ET-111265	Silver



EEMANN TECH SOLID COMBAT SAFETY FOR 1911/2011

Reference nr.	Color
ET-111266	Black
ET-111267	Silver



EEMANN TECH COMPETITION THUMB SAFETY WITH SHIELD FOR 1911/2011

Reference nr.
ET-211929



EEMANN TECH ALUMINIUM MAGWELL FOR STI 2011

Reference nr.	Color	
ET-110003	Black	NEW
ET-110004	Silver	NEW



EEMANN TECH MAGWELL FOR 2011

Reference nr.	Color
ET-211180	Black
ET-212180	Silver



EEMANN TECH TWO PIECES MAGWELL FOR 1911, 25LPI CHECKERED

Reference nr.	Color	Height
ET-111180	Black	47,2 mm
ET-111181	Silver	47,2 mm

Magwell size: 32×48×5mm



EEMANN TECH MAINSPRING HOUSING FOR 1911, 25LPI CHECKERED, FLAT*

Reference nr.	Color	Height
ET-111192	Black	48,6 mm
ET-111191	Silver	48,6 mm

*For installation without magwell



EEMANN TECH MAINSPRING HOUSING FLAT FOR 2011, CHECKERED 25 LPI

Reference nr.	Color
ET-111184	Black
ET-111185	Silver





EEMANN TECH DEMON HAMMER FOR 1911/2011

Reference nr.	Color
ET-111400	Silver
ET-111409	Black



EEMANN TECH PREMIUM MATCH HAMMER FOR 1911/2011

Reference nr.	Color
ET-111401	Silver



EEMANN TECH COMMANDER HAMMER FOR 1911/2011

Reference nr.	Color
ET-111402	Silver
ET-111406	Black



EEMANN TECH PRO HAMMER FOR 1911/2011

Reference nr.	Color
ET-111403	Silver
ET-111408	Black



EEMANN TECH ULTRA LIGHT COMPETITION HAMMER FOR 1911/2011

Reference nr.	Color
ET-111404	Silver



EEMANN TECH ULTRA LIGHT COMPETITION HAMMER FOR 1911/2011 - BLACK

Reference nr.
ET-111405



EEMANN TECH DISCONNECTOR FOR 1911/2011

Reference nr.	Color
ET-111380	Black



EEMANN TECH RECOIL SPRING GUIDE ROD FOR 1911/2011

Reference nr.	Barrel Length
ET-111311	4.0"
ET-111310	5.0"
ET-111312	6.0"



EEMANN TECH COMPETITION GUIDE ROD TOOL-LESS FOR 1911/2011*

Reference nr.
ET-110001

*Recoil Spring is not included



EEMANN TECH COMPETITION SEAR FOR 1911/2011

Reference nr.	Material
ET-112390	Stainless Steel
ET-111390	Steel



EEMANN TECH EJECTOR FOR 1911/2011

Reference nr.	Caliber
ET-111450	9×19 mm
ET-111451	.40S&W
ET-111452	.45auto

.40S&W

.45auto



EEMANN TECH HAMMER STRUT FOR 1911/2011

Reference nr.	Color
ET-111410	Black



EEMANN TECH ALUMINIUM TOOLLESS BASE PAD
FOR 2011 - BLACK

Reference nr.	Color
ET-111535	Black



EEMANN TECH ALUMINIUM TOOLLESS BASE PAD
FOR 2011 - SILVER

Reference nr.	Color
ET-111540	Silver





EEMANN TECH BARREL BUSHING FOR 1911

Reference nr.	Length	Color
ET-111340	21,1 mm	Silver
ET-111341	12,8 mm	Silver
ET-111342	21,1 mm	Black
ET-111343	12,8 mm	Black



EEMANN TECH RECOIL SPRING PLUG BUSHING BARREL FOR 1911/2011

Reference nr.	Color
ET-111316	Black
ET-111317	Silver



EEMANN TECH BARREL LINK FOR 1911/2011

Reference nr.	Size
ET-111371	#1
ET-111372	#2
ET-111373	#3
ET-111374	#4
ET-111375	#5



EEMANN TECH COMPETITION BUFFERS 5 PCS. SET FOR 1911/2011

Reference nr.
ET-303011





EEMANN TECH SLIDE STOP WITH THUMB REST FOR CZ SHADOW 2 - BLACK



Reference nr.	Color
ET-130050	Black

Advantages:

- No firearm modification required
- No fitting required and instant installation
- Provides stability and consistent grip for recoil control
- Slide stop thumb rest functions as a normal slide stop allowing slide to lock back if required
- When installed, fits in the IPSC Standard gun box
- Legal in Standard and Open divisions
- Not legal in IPSC Production division

Compatible with:

- CZ Shadow 2
- CZ Shadow 2 Compact
- CZ 75D Compact
- CZ 75 Tactical Sports
- CZ P01

Installation:

Remove the existing slide stop and replace it with the Eemann Tech slide stop with thumb rest.

Color:

Black

Specifications:

- Total width: 41.5mm
- Thumb rest width: 11mm
- Weight: 13g





EEMANN TECH COMPETITION SLIDE STOP WITH THUMB REST FOR CZ SHADOW 2 / CZ TS / CZ TS2

Reference nr.	Color
ET-130078	Black

Advantages:

- No firearm modification required
No fitting required and instant installation
- Provides stability and consistent grip for recoil control
Slide stop function is disabled!
- When installed, fits in the IPSC Standard gun box
- Legal in IPSC Standard and IPSC Open divisions
- Not legal in IPSC Production division

Compatible with:

- CZ Shadow 2 and their models
- CZ 75D Compact
- CZ 75 Tactical Sports and their models
- CZ P01
- CZ TS 2 and their models

Installation:

Easy installation by removing the existing slide stop and replacing it with the Eemmann Tech Competition Slide Stop with Thumb Rest.

Specifications:

Total width: 44.6 mm
Thumb rest width: 11 mm
Weight: 13 grams

NB! The slide stop function is disabled!





EEMANN TECH SLIDE STOP WITH THUMB REST FOR CZ 75 TACTICAL SPORT

Reference nr.	Color
ET-130065	Black

Advantages:

- No firearm modification required
- No fitting required and instant installation
- Provides stability and consistent grip for recoil control
- Slide stop thumb rest functions as a normal slide stop allowing slide to lock back if required
- When installed, fits in the IPSC Standard gun box
- Legal in Standard and Open divisions

Compatible:

- CZ 75 Tactical Sports
- CZ Shadow 2
- CZ 75D Compact
- CZ TS 2

Installation:

Remove existing slide stop and replace with Eemmann Tech slide stop with thumb rest

Specifications:

Total width:	41,5 mm
Thumb rest width:	11 mm
Weight:	13 g



EEMANN TECH SLIDE STOP WITH THUMB REST FOR CZ TS / TS2 - GREY



Reference nr.	Color
ET-130069	Grey

Advantages:

- No firearm modification required
- No fitting required and instant installation
- Provides stability and consistent grip for recoil control
- Slide stop thumb rest functions as a normal slide stop allowing slide to lock back if required
- When installed, fits in the IPSC Standard gun box
- Legal in Standard and Open IPSC divisions, USPSA PRODUCTION

Compatible:

- CZ 75 Tactical Sports
- CZ TS 2 and their models
- CZ Shadow 2
- CZ 75D Compact

Installation:

Remove existing slide stop and replace with Eemann Tech slide stop with thumb rest.

Specifications:

Total width: 41.5mm

Thumb rest width: 11mm

Weight: 13g





EEMANN TECH SLIDE STOP WITH THUMB REST FOR CZ 75 - BLACK

Reference nr.	Color
ET-130046	Black

Advantages:

- No firearm modification required
- No fitting required and instant installation
- Provides stability and consistent grip for recoil control
- Slide stop thumb rest functions as a normal slide stop allowing slide to lock back if required
- When installed, fits in the IPSC Standard gun box with OEM Safety
- Legal in Standard and Open divisions
- Not legal in IPSC Production division

Compatible:

- CZ 75 B
- CZ 75 Shadow Line
- CZ 75 SP-01
- CZ 75 SP-01 Shadow

Installation:

Remove the existing slide stop and replace it with the Eemann Tech slide stop with thumb rest.

Specifications:

Total width: 41.5mm

Thumb rest width: 11mm

Weight: 13g





EEMANN TECH SLIDE STOP WITH THUMB REST FOR CZ 75 - GREY

Reference nr.	Color
ET-130077	Grey

Advantages:

- No firearm modification required
- No fitting required and instant installation
- Provides stability and consistent grip for recoil control
- Slide stop thumb rest functions as a normal slide stop allowing slide to lock back if required
- When installed, fits in the IPSC Standard gun box with OEM Safety
- Legal in Standard and Open divisions
- Not legal in IPSC Production division

Compatible:

- CZ 75 B
- CZ 75 Shadow Line
- CZ 75 SP-01
- CZ 75 SP-01 Shadow

Installation:

Remove the existing slide stop and replace it with the Eemann Tech slide stop with thumb rest.

Specifications:

Total width: 41.5mm

Thumb rest width: 11mm

Weight: 13g



EEMANN TECH THUMB REST SLIDE STOP FOR CZ SHADOW 2/TS/TS2

Reference nr.	Color
ET-130127	Black

We are excited to present the Eemann Tech Thumb Rest Slide Stop for the CZ Shadow 2 / TS / TS2 pistols and their models.

Compatible with:

- CZ Shadow 2
- CZ Shadow 2 Orange
- CZ Shadow 2 Compact
- CZ 75 Tactical Sport
- CZ TS2
- CZ TS2 Race Green
- CZ TS2 Bronze

Total width: ~44 mm

Thumbrest width: ~33 mm

Material: Steel



EEMANN TECH THUMB REST SLIDE STOP FOR CZ 75 - BLACK



Reference nr.	Color
ET-130135	Black

We are excited to present the Eemann Tech Thumb Rest Slide Stop for the CZ 75 / CZ 75 SP-01 Shadow pistols and their models.

It is compatible with small, medium and large size hands. Just put your finger on the thumb rest and feel the difference!

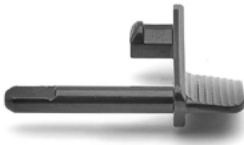

The Eemann Tech Thumb Rest Slide Stop for CZ 75 / 75 SP-01 Shadow is made from one piece of carbon steel and CNC machined to the highest standards.

It is designed to be used with CZ Shadow 75 / 75 SP-01 Shadow firearms and their models.



Total width: ~44mm (~1,73")

Thumb rest width: ~33mm (~1,29")

Material: Steel





EEMANN TECH SOLID SLIDE STOP FOR CZ 75

Reference nr.

ET-130080

Made from high quality high-wear resistant steel from one piece of metal.

Compatible with:

- CZ 75 SP-01
- CZ 75 SP-01 Shadow
- CZ 75 SP-01 Shadow Orange

Material: Steel**Color:** Black



EEMANN TECH SOLID SLIDE STOP FOR CZ SHADOW 2

Reference nr.

ET-130090

Made from high quality high-wear resistant steel from one piece of metal.

Compatible with:

- CZ Shadow 2
- CZ 75 D Compact
- CZ 75 Tactical Sports
- CZ P01

Material: Steel**Color:** Black

EEMANN TECH FLAT SLIDE STOP FOR CZ 75 SP-01

Reference nr.

ET-130163

NEW

Made of durable steel, this slide stop ensures enhanced control and a refined look, compatible with multiple CZ 75 models.

Compatible with:

- CZ 75 Shadow Line
- CZ 75 SP-01
- CZ 75 SP-01 Shadow
- CZ 75 SP-01 Shadow Orange

Material: Steel

Color: Black



EEMANN TECH SLIDE STOP WITH THUMB REST FOR CZ SHADOW 2 - GREY

Reference nr.

ET-130053

The Eemann Tech slide stop with thumb rest is crafted from a single piece of carbon steel and CNC machined to the highest standards. It is specifically designed for use with the CZ SHADOW 2 pistol.

Compatible with:

- CZ 75 Shadow Line
- CZ 75 SP-01
- CZ 75 SP-01 Shadow
- CZ 75 SP-01 Shadow Orange

Material: Steel**Color:** Grey

EEMANN TECH ADJUSTABLE THUMB REST

Reference nr.

ET-130047

The Eemann Tech Adjustable Thumb Rest is designed for any flat steel frame pistol. It is specifically installed on the left-hand side of the pistol for right-handed shooters.

Compatible with:

- CZ 75 Shadow Line
- CZ 75 SP-01
- CZ 75 SP-01 Shadow
- CZ 75 SP-01 Shadow Orange

Material: Aluminium





EEMANN TECH SOLID FLAT SLIDE STOP FOR CZ TS/TS2

Reference nr.

ET-130116

NEW

The Eemann Tech Solid Slide Stop is a high-quality, precision-machined replacement part designed for CZ TS, TS2, and Shadow 2 pistols.

Compatible with:

- CZ Shadow 2
- CZ TS2 (including Bronze, Race Green, Orange)
- CZ 75 Tactical Sports

Material: Steel (machined from a single piece)





Eemann Tech Ultimate Brass Long Grips for CZ

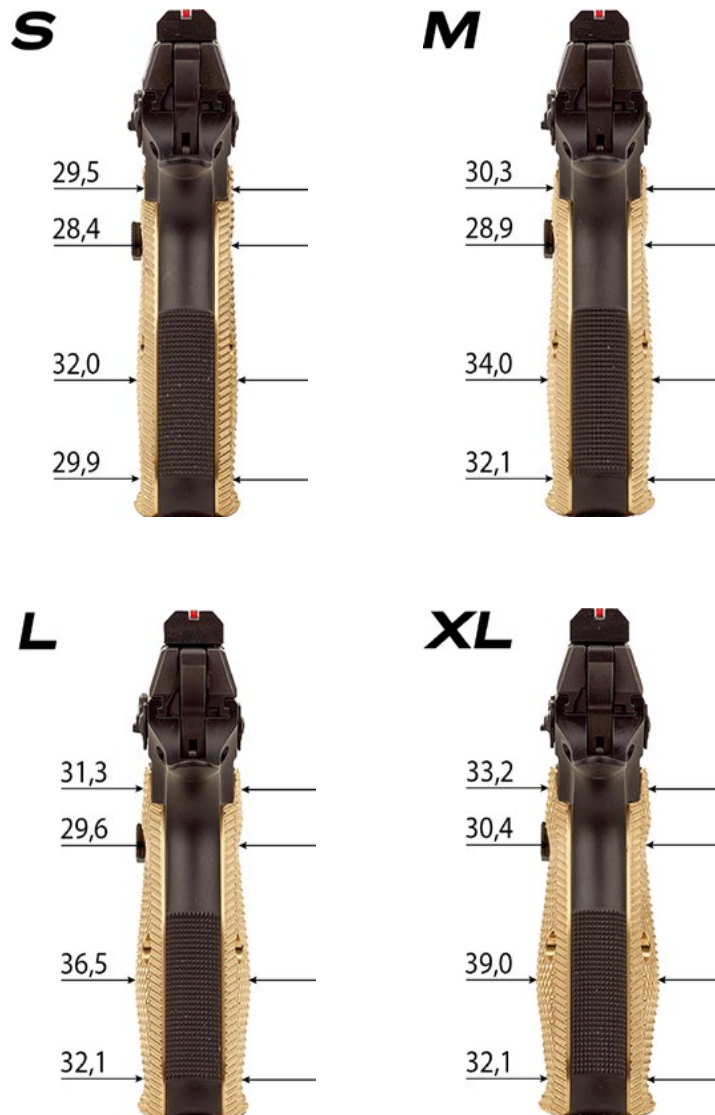

The Eemann Tech Ultimate Long grips are crafted from premium brass, featuring a specially designed rough surface for optimal performance and a firm grip.

Material: Brass

Set contains:

- 1 x Ultimate Brass Long Grip Left
- 1 x Ultimate Brass Long Grip Right
- 2 x Grip Tape Set (ET-130022)
- 2 x CZ OEM Grip Screw

Available sizes:

- Small - thickness: 5,5 mm
- Medium - thickness: 6,5 mm
- Large - thickness: 7,5 mm
- Extra Large - thickness: 9,0 mm

Weight:

- Small - 93 gr (1 pc) / 186 gr (2 pcs)
- Medium - 103 gr (1 pc) / 206 gr (2 pcs)
- Large - 113 gr (1 pc) / 226 gr (2 pcs)
- Extra Large - 125 gr (1 pc) / 250 gr (2 pcs)

Eemann Tech Brass Long Grips for CZ 75, CZ 75 TS, CZ SHADOW 2

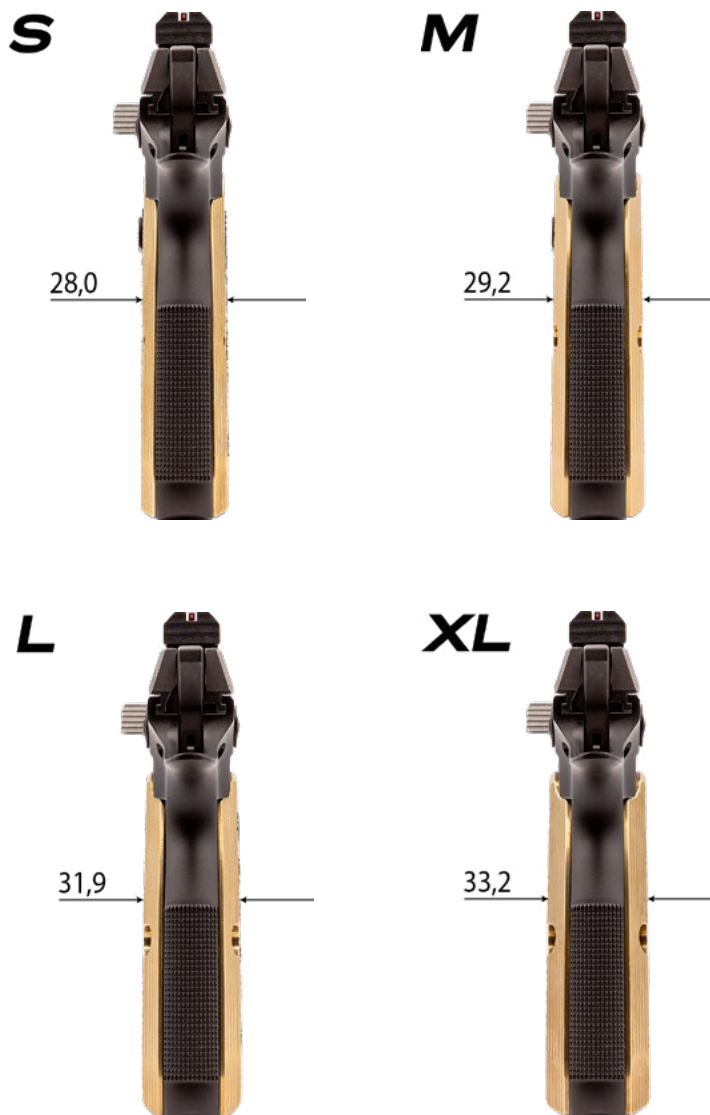

Made from brass, these grips increase the weight of the pistol, improving balance when shooting. They are attached using factory screws, with a spare set provided. To prevent the grip panels from becoming loose, it is recommended to use Blue Loctite or a mild strength thread locker.

Material: Brass

Set contains:

- 1 x Brass Long Grip Left
- 1 x Brass Long Grip Right
- 2 x Grip Tape Set (ET-130022)
- 2 x CZ OEM Grip Screw

Available sizes:

- Small - thickness: 0,8 mm
- Medium - thickness: 1,8 mm
- Large - thickness: 2,8 mm
- Extra Large - thickness: 3,8 mm

Weight:

- Small - 68 gr (1 pc) / 136 gr (2 pcs)
- Medium - 93 gr (1 pc) / 186 gr (2 pcs)
- Large - 117 gr (1 pc) / 234 gr (2 pcs)
- Extra Large - 145 gr (1 pc) / 289 gr (2 pcs)



EEMANN TECH BRASS LONG GRIPS FOR CZ 75, CZ 75 TS, CZ SHADOW 2*

Reference nr.	Size	Thickness
ET-130018	Small	0,8 mm
ET-130019	Medium	1,8 mm
ET-130020	Large	2,8 mm
ET-130021	Extra Large	3,8 mm

*For using without Magwell!



EEMANN TECH BRASS SHORT GRIPS FOR CZ 75, CZ 75 TS, CZ SHADOW 2*

Reference nr.	Size	Thickness
ET-130026	Small	0,8 mm
ET-130027	Medium	1,8 mm
ET-130028	Large	2,8 mm
ET-130029	Extra Large	3,8 mm

*For using with Magwell!



EEMANN TECH GRIP TAPE SET FOR CZ

Reference nr.	Color
ET-130022	Black



EEMANN TECH ULTIMATE BRASS GRIPS FOR CZ SHADOW 2 COMPACT

Reference nr.	Size	
ET-130261	Small	NEW
ET-130262	Medium	NEW
ET-130263	Large	NEW
ET-130264	Extra Large	NEW



EEMANN TECH ULTIMATE BRASS LONG GRIPS FOR CZ

Reference nr.	Size
ET-130141	Small
ET-130142	Medium
ET-130143	Large
ET-130144	Extra Large



THE EEMANN TECH TRIGGER FOR CZ 75 (SINGLE ACTION ONLY)

BACK-SHIFTED

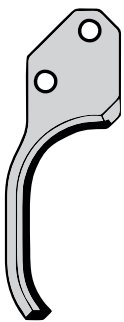

STRAIGHT



HOOKED



FRONT-SHIFTED



EXTRA FRONT-SHIFTED

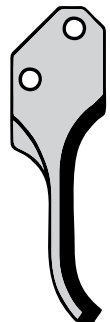

BLUE



RED



BLACK



SILVER



GOLD



EEMANN TECH TRIGGER FOR CZ 75, STRAIGHT

Reference nr.	Colour	Type
ET-012101	Blue	Smooth
ET-012103	Red	Smooth
ET-012104	Black	Smooth
ET-012105	White	Smooth
ET-012106	Yellow	Smooth



Reference nr.	Colour	Type
ET-012108	Blue	Serrated
ET-012110	Red	Serrated
ET-012111	Black	Serrated
ET-012112	White	Serrated
ET-012113	Yellow	Serrated



EEMANN TECH TRIGGER FOR CZ 75, HOOKED

Reference nr.	Colour	Type
ET-012115	Blue	Smooth
ET-012117	Red	Smooth
ET-012118	Black	Smooth
ET-012119	White	Smooth
ET-012120	Yellow	Smooth



Reference nr.	Colour	Type
ET-012122	Blue	Serrated
ET-012124	Red	Serrated
ET-012125	Black	Serrated
ET-012126	White	Serrated
ET-012127	Yellow	Serrated



EEMANN TECH TRIGGER FOR CZ 75, EXTRA FRONT-SHIFTED

Reference nr.	Colour	Type
ET-012157	Blue	Smooth
ET-012159	Red	Smooth
ET-012160	Black	Smooth
ET-012161	White	Smooth
ET-012162	Yellow	Smooth



Reference nr.	Colour	Type
ET-012164	Blue	Serrated
ET-012166	Red	Serrated
ET-012167	Black	Serrated
ET-012168	White	Serrated
ET-012169	Yellow	Serrated

EEMANN TECH TRIGGER FOR CZ 75,
BACK-SHIFTED

Reference nr.	Colour	Type
ET-012143	Blue	Smooth
ET-012145	Red	Smooth
ET-012146	Black	Smooth
ET-012147	Grey	Smooth
ET-012148	Gold	Smooth



Reference nr.	Colour	Type
ET-012150	Blue	Serrated
ET-012152	Red	Serrated
ET-012153	Black	Serrated
ET-012154	Grey	Serrated
ET-012155	Gold	Serrated

EEMANN TECH TRIGGER FOR CZ 75,
FRONT-SHIFTED

Reference nr.	Colour	Type
ET-012129	Blue	Smooth
ET-012131	Red	Smooth
ET-012132	Black	Smooth
ET-012133	Grey	Smooth
ET-012134	Gold	Smooth



Reference nr.	Colour	Type
ET-012136	Blue	Serrated
ET-012138	Red	Serrated
ET-012139	Black	Serrated
ET-012140	Grey	Serrated
ET-012141	Gold	Serrated



EEMANN TECH ULTIMATE TRIGGER FOR CZ

Reference nr.	Color	Material
ET-130084	Black	Aluminium
ET-130085	Silver	Aluminium
ET-130086	Gold	Brass
ET-130088	Black	Steel

Compatible with:

CZ 75
 CZ 75 SP-01
 CZ 75 SP-01 Shadow
 CZ 75 SP-01 Phantom
 CZ 75 SP-01 Shadow Line
 CZ 75 SP-01 Shadow Orange
 CZ 75 SP-01 Tactical
 CZ 75 B&BD
 CZ Shadow 2
 CZ Shadow 2 Orange





EEMANN TECH FLAT SA/DA TRIGGER FOR CZ

Reference nr.	Colour
ET-130081	Gold
ET-130082	Silver
ET-130083	Black

The DA / SA Flat Trigger allows for more precise control of the trigger press and reset!

The Eemann Tech SA / DA Flat Trigger for CZ has been specially produced for use in Double Action mode with your CZ pistol



Works perfectly with all steel framed CZ pistols with any installed disconnecter

Compatible with:

- CZ 75
- CZ 75 SP-01
- CZ 75 SP-01 Shadow
- CZ 75 SP-01 Phantom
- CZ 75 SP-01 Shadow Line
- CZ 75 SP-01 Shadow Orange
- CZ 75 SP-01 Tactical
- CZ 75 B&BD
- CZ Shadow 2
- CZ Shadow 2 Orange



The set includes:

- Flat Trigger
- Screw for Eemann Tech triggers for CZ (ET-131002)
- Competition Trigger Pin (ET-130064)
- Competition Trigger Spring (ET-131109)
- 1.5 mm L-Shape Hex Key (ET-030012)



EEMANN TECH REACH REDUCTION TRIGGER KIT FOR CZ SHADOW 1/2



Reference nr.

ET-130140

The Eemann Tech Reach Reduction Trigger Kit for CZ Shadow 1/2 is developed for shooters with smaller hands or those wanting to improve finger placement for enhanced trigger control, giving the possibility to use the maximum performance of CZ pistols.

Compatible with:

- CZ 75
- CZ 75 SP-01
- CZ 75 SP-01 Shadow
- CZ 75 SP-01 Phantom
- CZ 75 SP-01 Shadow Line
- CZ 75 SP-01 Shadow Orange
- CZ 75 SP-01 Tactical
- CZ Shadow 2
- CZ Shadow 2 Orange
- CZ 97 and their models

The set includes:

- RR Trigger for CZ Shadow
- Screw for Eemann Tech Triggers (after-travel) for CZ (ET-131002)
- Screw for Eemann Tech Triggers (pre-travel) for CZ (ET-131003)
- Competition Trigger Pin (ET-130064)
- Competition Trigger Spring (ET-131109)
- Ultimate Disconnecter for CZ (ET-130124)
- Hex Key 1.5 mm L-Shaped (ET-030012)



Eemann Tech Front Sight for CZ 75, Checkered With 1mm Fiber Optics Rod



Sight your picture



EEMANN TECH CZ 75 FRONT SIGHT, CHECKERED, STEEL

Reference nr.	Height	Width
ET-130100	5,50 mm	3,00 mm
ET-130101	6,00 mm	3,00 mm
ET-130102	6,50 mm	3,00 mm
ET-130103	7,00 mm	3,00 mm
ET-130104	7,50 mm	3,00 mm
ET-130105	8,00 mm	3,00 mm



EEMANN TECH FRONT SIGHT FOR CZ 75, CHECKERED WITH 1MM FIBER OPTICS ROD

Reference nr.	Height	Width
ET-130200	5,00 mm	2,70 mm
ET-130201	5,00 mm	3,00 mm
ET-130202	5,25 mm	2,70 mm
ET-130203	5,25 mm	3,00 mm
ET-130326	5,50 mm	2,40 mm
ET-130204	5,50 mm	2,70 mm
ET-130205	5,50 mm	3,00 mm
ET-130206	5,75 mm	2,70 mm
ET-130207	5,75 mm	3,00 mm
ET-130208	6,00 mm	2,70 mm
ET-130209	6,00 mm	3,00 mm
ET-130210	6,25 mm	2,70 mm
ET-130211	6,25 mm	3,00 mm
ET-130212	6,50 mm	2,70 mm
ET-130213	6,50 mm	3,00 mm
ET-130216	7,00 mm	2,70 mm
ET-130217	7,00 mm	3,00 mm
ET-130220	7,50 mm	2,70 mm
ET-130221	7,50 mm	3,00 mm
ET-130224	8,00 mm	2,70 mm
ET-130225	8,00 mm	3,00 mm
ET-130226	9,50 mm	3,00 mm



EEMANN TECH FRONT SIGHT FOR CZ 75, CZ SHADOW 2 CHECKERED WITH 1,5 MM FIBER OPTICS ROD

Reference nr.	Height	Width
ET-130304	5,50 mm	2,70 mm
ET-130305	5,50 mm	3,00 mm
ET-130306	5,75 mm	2,70 mm
ET-130307	5,75 mm	3,00 mm
ET-130308	6,00 mm	2,70 mm
ET-130309	6,00 mm	3,00 mm
ET-130312	6,50 mm	2,70 mm
ET-130313	6,50 mm	3,00 mm
ET-130316	7,00 mm	2,70 mm
ET-130317	7,00 mm	3,00 mm
ET-130320	7,50 mm	2,70 mm
ET-130321	7,50 mm	3,00 mm
ET-130324	8,00 mm	2,70 mm
ET-130325	8,00 mm	3,00 mm



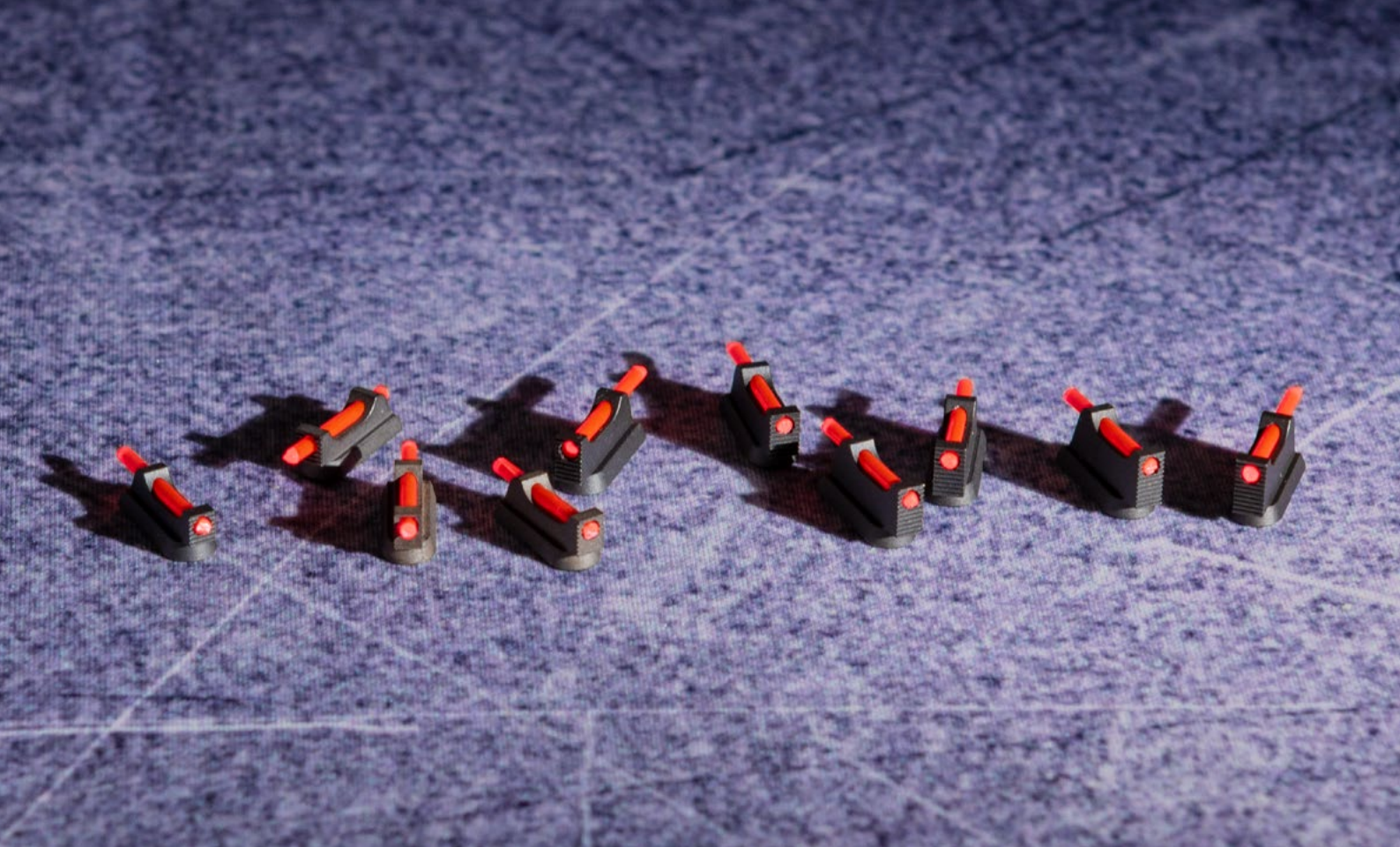

EEMANN TECH FRONT SIGHT FOR CZ SHADOW 2
ORANGE, CHECKERED, WITH 1MM FIBER OPTICS
ROD

Reference nr.	Height	Width
ET-130234	7,00 mm	2,70 mm
ET-130235	7,50 mm	2,70 mm
ET-130236	8,00 mm	2,70 mm
ET-130231	7,00 mm	3,00 mm
ET-130232	7,50 mm	3,00 mm
ET-130233	8,00 mm	3,00 mm

Eemann Tech Front Sight
for CZ SHADOW 2 ORANGE,
Checkered, with 1mm Fiber Optics Rod

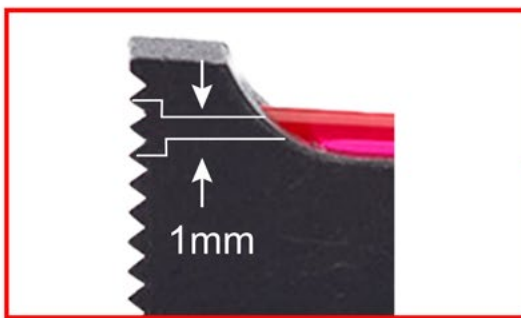

- Serrated surface (non-glare properties)
- Additional space for fiber rod installation
- Fiber optics rod diameter: 1mm



Available Heights: 7.0 mm, 7.5 mm, 8.0 mm
Available Widths: 2.7 mm, 3.0 mm

Sight your picture





EEMANN TECH ADJUSTABLE REAR SIGHT
FOR CZ 75

Reference nr.

ET-130500



EEMANN TECH ADJUSTABLE REAR SIGHT WITH
FIBER OPTICS FOR CZ 75

Reference nr.

ET-130600



EEMANN TECH COMPETITION FRONT SIGHT FOR
CZ P-10

Reference nr.

ET-130071



EEMANN TECH ADJUSTABLE SIGHTS SET FOR
CZ P-10

Reference nr.

ET-130070



EEMANN TECH ADJUSTABLE REAR SIGHT FOR CZ
P-10

Reference nr.

ET-130074



EEMANN TECH ADJUSTABLE REAR SIGHT
FOR CZ SP-01 SHADOW

Reference nr.

ET-130008



EEMANN TECH ADJUSTABLE REAR SIGHT WITH
FIBER OPTICS FOR CZ SP-01 SHADOW

Reference nr.

ET-012025



EEMANN TECH ADJUSTABLE REAR SIGHT
FOR CZ 75 TS

Reference nr.

ET-130030



EEMANN TECH ADJUSTABLE REAR SIGHT WITH
FIBER OPTICS FOR CZ 75 TS

Reference nr.

ET-130031



EEMANN TECH ADJUSTABLE SIGHTS SET FOR CZ SHADOW

Reference nr.	Diameter
ET-130113	1,0 mm
ET-130114	1,5 mm

The set of Eemann Tech Adjustable Sights for CZ Shadow has been designed specifically for IPSC or Target Shooting disciplines (USPSA, IPSC, IDPA, Steel Challenge, ISSF).

This adjustable rear sight is intended only for CZ 75 SP-01 SHADOW and CZ SHADOW 2 pistols.

One click of vertical or horizontal adjusting screw corresponds approximately to 1 cm on the target at distance of 25 m (sights radius on CZ SP-01 SHADOW is 17 cm).

The height of the front end of the Eemann Tech CZ 75 Front Sight is lower than its back end for making the visible side of the sight sharper while aiming.





EEMANN TECH CZ P-10 OR PLATE MOUNT FOR HOLOSUN 407K/507K

Reference nr.

ET-130156



EEMANN TECH CZ P-10 OR PLATE MOUNT FOR TRIJICON RMR / HOLOSUN 507COMP

Reference nr.

ET-130157



EEMANN TECH CZ P-10 OR PLATE MOUNT FOR SHIELD RMS

Reference nr.

ET-130158



EEMANN TECH CZ P-10 OR PLATE MOUNT FOR VORTEX VENOM

Reference nr.

ET-130159



EEMANN TECH CZ SHADOW 2 OR PLATE MOUNT FOR VORTEX VENOM

Reference nr.

ET-130150





EEMANN TECH ALUMINIUM RED DOT MOUNT FOR CZ TS/TS2

Reference nr.	Type	
ET-130907	V1	NEW
ET-130908	V2	NEW



EEMANN TECH ALUMINIUM RED DOT MOUNT FOR CZ SHADOW / SHADOW 2

Reference nr.	Type	
ET-130901	V1	
ET-130902	V2	



EEMANN TECH ALUMINIUM RED DOT MOUNT FOR CZ 75/85 (NOT SHADOW MODELS)

Reference nr.	Type	
ET-130903	V1	
ET-130904	V2	



EEMANN TECH CZ SHADOW 2 OR PLATE MOUNT
FOR C-MORE RTS

Reference nr.

ET-130151



EEMANN TECH CZ SHADOW 2 OR PLATE MOUNT
FOR TRIJICON RMR

Reference nr.

ET-130152



EEMANN TECH CZ SHADOW 2 OR PLATE MOUNT
FOR LEUPOLD DELTA

Reference nr.

ET-130153



EEMANN TECH CZ SHADOW 2 OR PLATE MOUNT
FOR SHIELD RMS

Reference nr.

ET-130154



EEMANN TECH CZ SHADOW 2 OR PLATE MOUNT
FOR HOLOSUN 407K/507K

Reference nr.

ET-130155



EEMANN TECH RED DOT MOUNT CZORV1 FOR CZ
SHADOW 2 OR

Reference nr.

ET-130132



EEMANN TECH FIRING PIN FOR CZ 75 SP-01



Reference nr.	Color
ET-130014	Black

EEMANN TECH COMPETITION FIRING PIN FOR CZ*



Reference nr.	Color
ET-130015	Black

*The extended firing pin resolves the misfire faults caused by weak main spring.



Born to perform



EEMANN TECH PIN FOR CZ 75

Reference nr.	Color
ET-130038	Silver



EEMANN TECH PINS SET FOR CZ

Reference nr.
ET-130062



EEMANN TECH TRIGGER PIN FOR CZ

Reference nr.
ET-130054



EEMANN TECH HAMMER STRUT PIN FOR CZ

Reference nr.
ET-130055



EEMANN TECH SEAR PIN FOR CZ

Reference nr.
ET-130056



EEMANN TECH MAIN SPRING PLUG PIN FOR CZ

Reference nr.
ET-130057



EEMANN TECH COMPETITION TRIGGER PIN FOR CZ

Reference nr.
ET-130064



EEMANN TECH PINS SET FOR CZ P-10

Reference nr.

ET-130115



EEMANN TECH FRONT SIGHT PIN FOR CZ

Reference nr.

ET-130058



EEMANN TECH EXTRACTOR PIN FOR CZ

Reference nr.

ET-130059



EEMANN TECH HAMMER PIN FOR CZ

Reference nr.

ET-130060



EEMANN TECH HAMMER PIN LOCK PIN FOR CZ

Reference nr.

ET-130061



EEMANN TECH PIN FOR CZ SHADOW 2 / TS / TS2

Reference nr.

ET-130110





EEMANN TECH SUPER LIGHT HAMMER FOR CZ

Reference nr.	Color
ET-130128	Black



EEMANN TECH ULTIMATE HAMMER FOR CZ

Reference nr.	Color
ET-130129	Black



EEMANN TECH CUSTOM ZERO DISCONNECTOR FOR CZ SHADOW

Reference nr.

ET-130160

The Eemann Tech Custom Zero Disconnecter for CZ is a specialized component designed to enhance trigger performance. Crafted from steel and finished in black, this disconnecter offers the possibility to adjust pre-travel in single action from any distance to zero.

ONLY FOR EXPERT SHOOTERS !

Installation by a qualified gunsmith is highly recommended to ensure proper functionality and safety. Installation involves precise adjustments, potentially requiring the removal of material from side A using a file or Dremel tool until the reset mechanism starts working correctly.

Specifications:

- Material: Steel
- Color: Black
- Custom component for CZ models
- Compatible with CZ Shadow 1/2 and similar models
- Professional installation required
- Adjustable pre-travel in single action

Product Contains:

- Eemann Tech Custom Zero Disconnecter - 1 pc.
- Eemann Tech Hammer Strut Pin for CZ - 1 pc.





EEMANN TECH ULTIMATE DISCONNECTOR FOR CZ SHADOW

Reference nr.

ET-130124

The Eemann Tech Ultimate Disconnecter for CZ 75, CZ 75-SP01 SHADOW, CZ Shadow 2 models.

After a few years of testing and getting feedback from our customers, we have improved the Eemann Tech Competition Disconnecter and released a brand-new design!

ONLY FOR EXPERT SHOOTERS !

Fits:

- CZ 75 (with or without firing pin block models)
- CZ 75 SP-01 Shadow models (CZ Shadow 1 or similar)
- CZ Shadow 2 and their models
- CZ Shadow 2 Orange and their models

The set includes:

- Eemann Tech Ultimate Disconnecter: 1 pc.
- CZ 75 Hammer Pin: 1 pc.

Material: Steel

Color: Black

CZ SHADOW 2

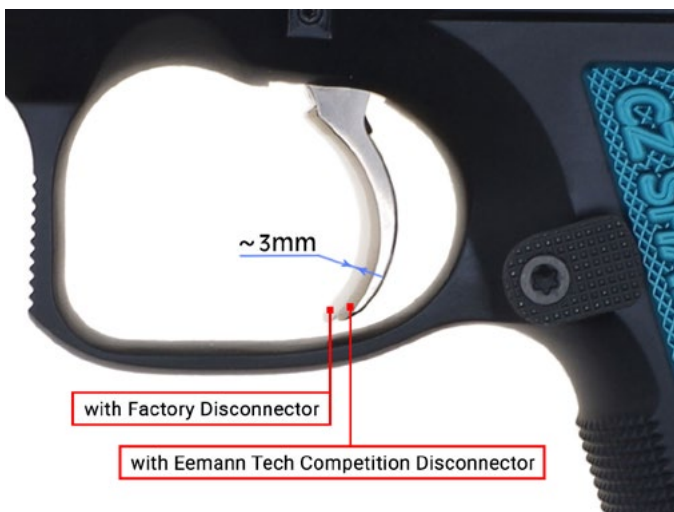

CZ 75 SP-01 SHADOW

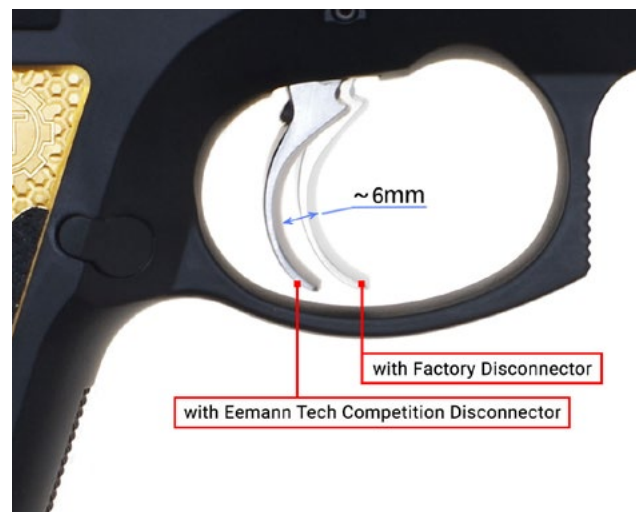



Eemann Tech Standard Base Pad for CZ 75, CZ 75 SP-01, CZ Shadow 2 - Silver

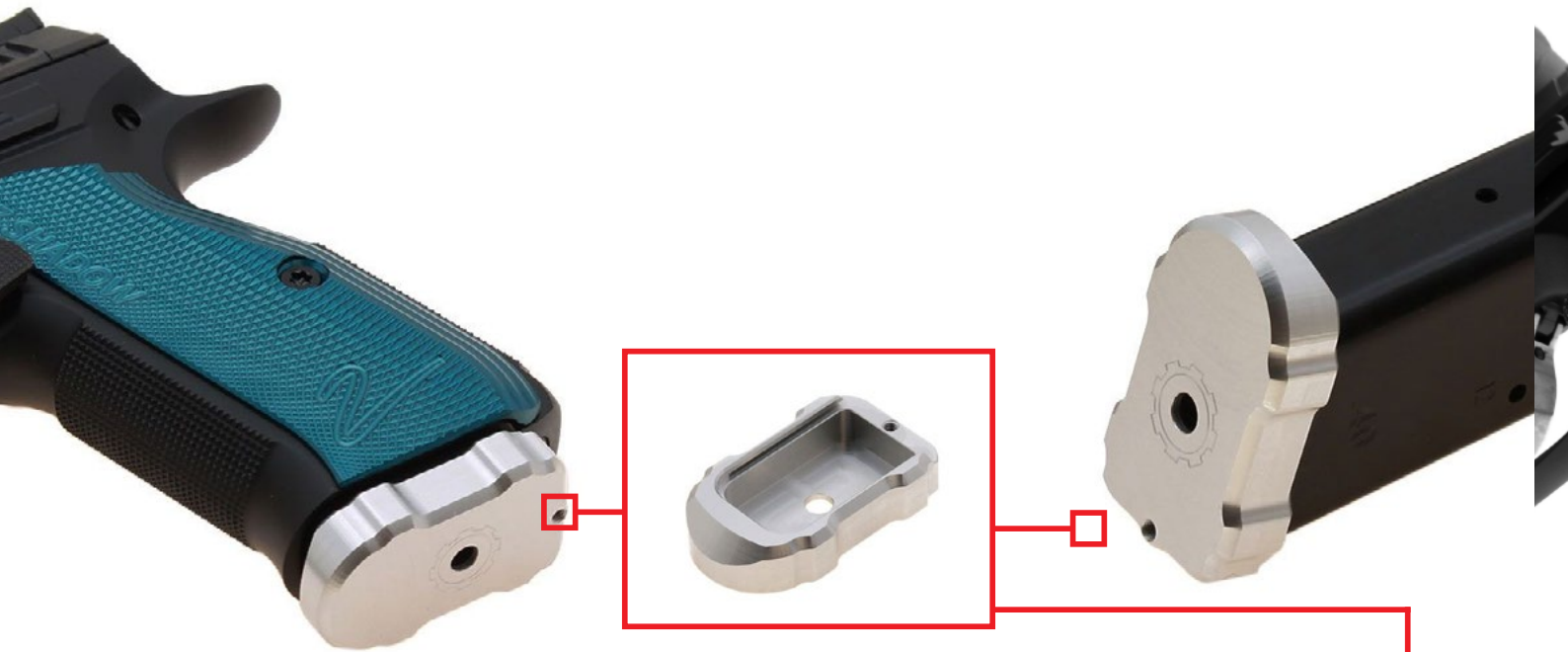

IPSC Standard box size: 225 × 150 × 45 mm

When **size** does matter

Eemann Tech Standard Base Pad for
CZ 75, CZ 75 SP-01, CZ Shadow 2



IPSC Standard box size: 225 × 150 × 45 mm

When **size** does matter



Eemann Tech Brass Standard Base Pad for CZ 75, CZ 75 SP-01, CZ Shadow 2



IPSC Standard box size: 225 × 150 × 45 mm

When **size** does matter



EEMANN TECH BRASS BASE PAD FOR CZ SHADOW 2

Reference nr.	Material
ET-130045	Aluminum

*Works with magwell



EEMANN TECH STANDARD BASE PAD FOR CZ 75, CZ 75 SP-01, CZ SHADOW 2 - BLACK*

Reference nr.	Material
ET-130016	Aluminum

*Works with magwell



EEMANN TECH STANDARD BASE PAD FOR CZ 75, CZ 75 SP-01, CZ SHADOW 2 - SILVER*

Reference nr.	Material
ET-130032	Aluminum

*Works with magwell



EEMANN TECH BRASS BASE PAD FOR CZ 75 TS / TS 2*

Reference nr.	Material
ET-130079	Brass

*Works with magwell



EEMANN TECH BRASS BASE PAD FOR CZ SHADOW 2

Reference nr.	Material
ET-130045	Brass



EEMANN TECH EXTENDED BASE PAD FOR CZ - 170MM

Reference nr.	Color	
ET-130194	Black	NEW



EEMANN TECH FULL LENGTH GUIDE ROD FOR CZ 75

Reference nr.	Color	
ET-130005	Black	



EEMANN TECH STEEL SHORT GUIDE ROD FOR CZ 75 TS

Reference nr.	Color	
ET-130007	Black	



EEMANN TECH GUIDE ROD FOR CZ SHADOW 2, CZ SHADOW 2 ORANGE

Reference nr.	Color	
ET-303016	Silver	



EEMANN TECH GUIDE ROD FOR CZ 75 SP-01 SHADOW, NEW DESIGN

Reference nr.	Color	
ET-130024	Silver	



EEMANN TECH COMPETITION GUIDE ROD FOR CZ TS / TSO / TS2

Reference nr.	Color	
ET-130076	Silver	



EEMANN TECH STEEL GUIDE ROD FOR CZ P-10F

Reference nr.		
ET-130089		



EEMANN TECH SEAR FOR CZ 75 / SHADOW 2

Reference nr.

ET-130025

NEW

EEMANN TECH BASE PAD LOCK FOR MEC-GAR
MAGAZINES

Reference nr.

ET-130108

NEW



EEMANN TECH MAIN SPRING STRUT FOR CZ

Reference nr.

ET-130123

Color

Black



EEMANN TECH FRAME WEIGHT FOR CZ SHADOW 2

Reference nr.

ET-130136

NEW

The Eemann Tech Frame Weight is engineered specifically for the CZ Shadow 2, providing enhanced balance and improved recoil control during rapid fire. Crafted from durable blackened carbon steel, this accessory adds approximately ~172 grams (~6.0 ounces) to the front of the pistol's frame, significantly boosting muzzle stability and shooting performance.

Compatible with: CZ Shadow 2 Frame

Material: Carbon Steel, blackened

Color: Black





EEMANN TECH EXTRACTOR FOR CZ SHADOW 1/2

Reference nr.

ET-130120

The Eemann Tech Extractor is designed for CZ Shadow 1/2, compatible with calibers 9×19 and 9×21. Crafted from steel, it ensures optimal performance.

Compatible with:

- CZ 75
- CZ 75B
- CZ 85B
- CZ SP 01 Shadow and their various models
- CZ Shadow 2
- CZ Shadow 2 Orange
- CZ 75 TS
- CZ 75 TS 2 (not compatible with CZ 75 stainless steel model)

Material: Steel**Caliber:** 9×19, 9×21**Color:** Black



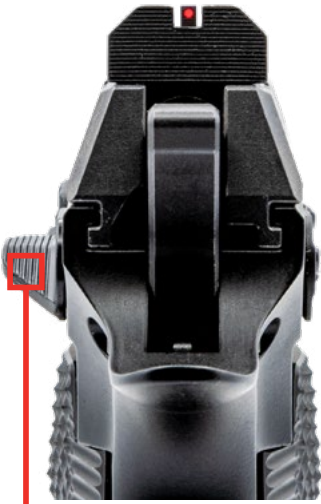

ET-130170

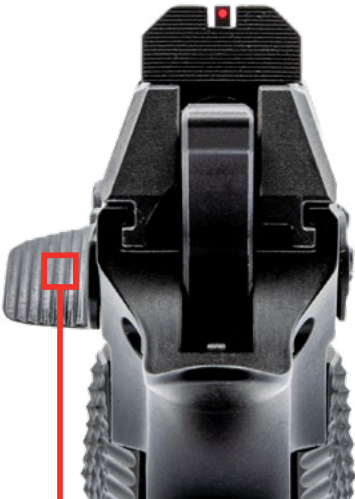

ET-130172



ET-130173

EEMANN TECH COMPETITION SAFETY LEFT FOR CZ SHADOW 2/TS

Reference nr.

ET-130170

The Eemann Tech Competition extended safety for CZ Shadow 2 / TS / TS2 is crafted from high-quality steel using modern technology. It mirrors the appearance of the factory wide safety and offers smoother operation with the safety plunger. This left-side competition safety is compatible with the factory right-side safety.

Material: Steel**Color:** Black**Compatibility:**

- CZ TS
- CZ TSO
- CZ TS2
- CZ TS2 Orange
- CZ Shadow 2
- CZ Shadow 2 Orange
- CZ Shadow 2 Compact
- CZ Czechmate





EEMANN TECH LOW PROFILE LARGE SAFETY LEFT FOR CZ SHADOW 2/TS

Reference nr.

ET-130172

NEW

The Eemmann Tech Low Profile Large Safety Left for CZ Shadow 2/TS is a high-quality replacement thumb safety. It features a low-profile design that is 3mm farther and 3mm lower than the factory OEM large safety. Made from durable carbon steel and treated with the best heat-treatment process, this safety is built for long-lasting performance. The black finish complements the firearm's design, while the large serrations on the thumb provide an excellent grip. This safety is fully compatible with the CZ OEM right-side safety, ensuring seamless operation and easy engagement or disengagement of the safety function.

Material: Carbon steel

Color: Black

Compatibility:

CZ Shadow 2, Tactical Sports (TS)

Works with CZ OEM right-side safety





EEMANN TECH FLAT SAFETY LEFT FOR CZ SHADOW 2/TS

Reference nr.

ET-130173

NEW

The Eemmann Tech Flat Safety Left is ideal for shooters who prefer not to use the safety lever as a thumb rest. This part is a direct replacement for the CZ factory flat safety (part number 0423-2500-01N) and is designed with a low-profile, flat construction. Made from high-quality carbon steel with a wear-resistant black finish, it guarantees durability and reliability. It's fully compatible with all CZ OEM right-side safeties, allowing for cost-effective customization by purchasing only the side you need.

Material: Carbon steel

Color: Black

Side: Left

Compatibility:

CZ OEM right-side safeties





EEMANN TECH FLAT SAFETY LEFT FOR CZ 75

Reference nr.

ET-130174

NEW



EEMANN TECH LOW SAFETY FOR THE CZ 75

Reference nr.

ET-130175

NEW



EEMANN TECH FRONT-SHIFTED SAFETY FOR CZ SHADOW 2/TS

Reference nr.

ET-130176

NEW





EEMANN TECH BRASS MAGWELL FOR CZ SHADOW 2

Reference nr.	Material
ET-130043	Brass

The Eemann Tech Brass Magwell (Magazine funnel) for CZ Shadow 2 will make your reloading faster, smoother and easier.

The goal of brass magwell is to increase the weight of the bottom of the gun, making it more stable during the shooting.

Material: Brass

Weight: 93g



EEMANN TECH BRASS MAGWELL FOR CZ 75 SP-01 SHADOW

Reference nr.	Material
ET-130023	Brass

The Eemann Tech Brass Magwell (Magazine funnel) for CZ 75 SP-01 Shadow will make your reload faster, smoother and easier.

CZ BRASS Magwell for:

- CZ 75 SP-01
- CZ 75 B
- CZ 75 Shadow Line

Material: Brass

Weight: 87 gr.



EEMANN TECH COMPETITION BRASS MAGWELL FOR CZ 75 TS/TS2

Reference nr.	Material
ET-130119	Brass

NEW

The Eemann Tech Competition Brass Magwell (Magazine funnel) for CZ 75 Tactical Sports & CZ TS 2 will make your reloading faster and easier. The goal of brass magwell is to increase the weight of the bottom of the gun, making it more stable during the shooting.

Fits in IPSC Standard Box with OEM sights and magazine.

Recommended to use with SHORT BRASS GRIPS from EEMANN TECH ET-130026, ET-130027, ET-130028, ET-130029

Material: Brass

Weight: 135 gr.



EEMANN TECH ALUMINIUM MAGWELL FOR CZ SHADOW 2 - BLACK

Reference nr.	Material	
ET-130109	High-grade aluminium	NEW

The Eemann Tech Aluminium Magwell for CZ Shadow 2 is engineered for shooters who demand speed, precision, and reliability.

Manufactured from high-grade aluminium and finished with a durable black anodizing, it provides a lightweight yet robust solution to improve reload times significantly.

Material: High-grade aluminium

Weight: 38g



EEMANN TECH MAGWELL FOR CZ SCORPION EVO 3

Reference nr.	Material	
ET-133928	Rigid plastic	

The Eemann Tech Magwell is expertly crafted for CZ Scorpion EVO 3 rifles.

Made from durable plastic using cutting-edge 3D printing technology, it significantly improves magazine reload speed by providing a larger funnel for quick and smooth magazine changes.

Material: Rigid plastic

Weight: 100g



EEMANN TECH ULTIMATE UPGRADE KIT FOR CZ SHADOW 1/2

Reference nr.

ET-130126

- ↳ ET-131179 - 1pc.
- ↳ ET-131180 - 1pc.
- ↳ ET-131181 - 1pc.
- ↳ ET-131182 - 1pc.
- ↳ ET-131187 - 1pc.
- ↳ ET-131188 - 1pc.
- ↳ ET-131189 - 1pc.
- ↳ ET-131190 - 1pc.
- ↳ ET-131109 - 2pc.
- ↳ ET-131156 - 1pc.
- ↳ ET-131113 - 1pc.
- ↳ ET-130124 - 1pc.
- ↳ ET-130015 - 1pc.
- ↳ ET-303017 - 2pc.
- ↳ ET-130064 - 1pc.
- ↳ ET-130055 - 1pc.

Compatible with:

- CZ 75 SP-01 (without firing pin block models)
- CZ 75 Shadow Line
- CZ 75 SP-01 Shadow
- CZ 75 SP-01 Shadow Orange
- CZ Shadow 2
- CZ Shadow 2 Orange





EEMANN TECH UPGRADE KIT FOR CZ 75 TS

Reference nr.

ET-130063

Eemann Tech Upgrade Kit ET-130063 for CZ 75 TS contains:

- ET-131139 Eemann Tech Recoil Spring for CZ 9lbs - 1pc.
- ET-131118 Eemann Tech Main Spring for CZ 8 lbs - 1pc.
- ET-132118 Eemann Tech Competition Trigger Spring for CZ 75 TS - 1pc.
- ET-131156 Eemann Tech Competition Firing Pin Spring for CZ - 1pc.
- ET-131113 Eemann Tech Competition Sear Spring for CZ 75 - 1pc.
- ET-130007 Eemann Tech Steel Guide Rod for CZ 75 TS - 1pc.
- ET-303014 Eemann Tech Competition Buffer for CZ 75 TS - 1pc.
- ET-012111 Eemann Tech SA Trigger for CZ, Straight, Serrated, Black - 1 pc.
- ET-130054 Eemann Tech Trigger Pin for CZ - 1pc.
- ET-030012 Eemann Tech HEX Key 1.5mm L-Shaped - 1pc.

Compatible with:

- CZ 75 TS
- CZ 75 TS Orange
- CZ 75 TS2
- CZ 75 TS2 RACE GREEN
- CZ 75 TS2 BRONZE
- CZ 75 TS2 Orange

EEMANN TECH UPGRADE KIT FOR CZ SHADOW 2

Reference nr.

ET-130052

**Eemann Tech Upgrade Kit ET-130052 for CZ Shadow 2 contains:**

- ET-131140 - Eemann Tech Recoil Spring for CZ - 10 lbs - 1pcs.
- ET-131118 - Eemann Tech Main Spring for CZ - 8 lbs - 1pcs.
- ET-131109 - Eemann Tech Competition Trigger Spring for CZ - 1pcs.
- ET-131156 - Eemann Tech Competition Firing Pin Spring for CZ - 1pcs.
- ET-131113 - Eemann Tech Competition Sear Spring for CZ - 1pcs.
- ET-130124 - Eemann Tech Ultimate Disconnecter for CZ - 1pcs.
- ET-130015 - Eemann Tech Extended Firing Pin for CZ - 1pcs.
- ET-303017 - Eemann Tech Competition Buffer for CZ - 1pcs.
- ET-130064 - Eemann Tech Competition Trigger Pin for CZ - 1pcs.
- ET-130055 - Eemann Tech Hammer Strut Pin for CZ - 1pcs.

Compatible with:

- CZ 75 SP-01 (without firing pin block)
- CZ 75 Shadow Line
- CZ 75 SP-01 Shadow
- CZ 75 SP-01 Shadow Orange
- CZ Shadow 2
- CZ Shadow 2 Orange





EEMANN TECH UPGRADE KIT FOR CZ 75 SP-01 SHADOW

Reference nr

ET-130051

Eemann Tech Upgrade Kit ET-130051 for CZ 75 SP-01 Shadow contains:

- ET-131140 Eemann Tech Recoil Spring for CZ 10lbs - 1pc.
- ET-131118 Eemann Tech Main Spring for CZ 8 lbs - 1pc.
- ET-131109 Eemann Tech Competition Trigger Spring for CZ 75 - 1pc.
- ET-131156 Eemann Tech Competition Firing Pin Spring for CZ - 1pc.
- ET-131113 Eemann Tech Competition Sear Spring for CZ 75 - 1pc.
- ET-130124 Eemann Tech Ultimate Disconnecter for CZ - 1pc.
- ET-130005 Eemann Tech Full Length Guide Rod for CZ - 1pc.
- ET-303017 Eemann Tech Competition Buffer for CZ - 1pc.
- ET-130064 Eemann Tech Competition Trigger Pin for CZ - 1pc.
- ET-130055 Eemann Tech Hammer Strut Pin for CZ - 1pc.

Testing in an off-the-shelf CZ 75 SP-01 produced the following average results:

Trigger pull DA: 2.94Kg/6.5Lbs

Trigger pull SA: 1.13Kg/2.5Lbs

Individual results may vary.

Compatible with:

CZ 75 SP-01 (without firing pin block models)

CZ 75 SP-01 Shadow

CZ 75 SP-01 Shadow Orange





EEMANN TECH PRECISE BARREL BUSHING FOR
CZ 85, CZ 75B, CZ 75D COMPACT

Reference nr.

ET-130048



EEMANN TECH PRECISE BARREL BUSHING FOR
CZ 75, CZ 75BD, CZ85B

Reference nr.

ET-130049



EEMANN TECH PRECISE BARREL BUSHING FOR
CZ 75-01 SHADOW, CZ SHADOW 2, CZ 75 TS

Reference nr.

ET-130034



EEMANN TECH PRECISE BARREL BUSHING FOR
CZ SHADOW 2 ORANGE

Reference nr.

ET-130161



EEMANN TECH PRECISE BUSHING HOUSING FOR
CZ SHADOW 2 ORANGE

Reference nr.

ET-130162



SPARE LOCATOR PIN V1C FOR EEMANN TECH RED
DOT MOUNT - 2 PCS./SET

Reference nr.

ET-130881



SPARE LOCATOR PIN V1A FOR EEMANN TECH RED
DOT MOUNT - 2 PCS./SET

Reference nr.

ET-130882



SPARE LOCATOR PIN V1E FOR EEMANN TECH RED
DOT MOUNT - 2 PCS./SET

Reference nr.

ET-130883



SPARE LOCATOR PIN V2B FOR EEMANN TECH RED
DOT MOUNT - 2 PCS./SET

Reference nr.

ET-130884



SPARE LOCATOR PIN V2D FOR EEMANN TECH RED
DOT MOUNT - 2 PCS./SET

Reference nr.

ET-130885



SPARE LOCATOR PIN V2F FOR EEMANN TECH RED
DOT MOUNT - 2 PCS./SET

Reference nr.

ET-130886





EEMANN TECH COMPETITION BUFFERS SET FOR CZ75/CZ75SP-01/CZ85

Reference nr.

ET-303013

Material:

Polyurethane

Notes:

Service life of the buffer is ~ 1,000 rounds
Oils and solvents resistant

Compatible with:

CZ 75 / 75 SP-01 / 85

Set contains:

Competition buffer - 5 pcs.
Package - 1 pc.
Instruction - 1 pc.



EEMANN TECH THIN BUFFER SET FOR CZ SHADOW 2

Reference nr.

ET-303018

Material:

Polyurethane

Notes:

Service life of the buffer is ~ 1000 rounds
(depending on the type of ammunition and springs)
Oils and solvents resistant

Compatible with:

CZ 75 / Shadow 1 / Shadow 2

Set contains:

Eemann Tech Thin buffer (thickness 2mm) - 5 pcs./set



EEMANN TECH GRIPS 4PCS. SET FOR GLOCK
BASE PADS

Reference nr.

ET-120040



EEMANN TECH COMPETITION GRIP TAPE FOR
GLOCK17 GEN5

Reference nr.

ET-120035



EEMANN TECH COMPETITION GRIP TAPE FOR
GLOCK17 GEN3

Reference nr.

ET-120037

NEW



EEMANN TECH COMPETITION MAGWELL FOR
GLOCK 17 GEN5

Reference nr.

ET-120050



EEMANN TECH STEEL MAGWELL FOR GLOCK17
GEN5

Reference nr.

ET-120065

NEW



EEMANN TECH ALUMINIUM MAGWELL FOR
GLOCK17 GEN5

Reference nr.

ET-120066

NEW



EEMANN
TECH WWW.EEMANN.TECH

Eemann Tech Adjustable Sights Set for GLOCK



EEMANN TECH ADJUSTABLE SIGHTS SET FOR GLOCK

Reference nr.	Diameter
ET-120027	1 mm
ET-120028	1,5 mm





EEMANN TECH HEAVY BRASS FEED GRIP PLUG FOR GLOCK 17 GEN4/5

Reference nr.

ET-120057

Specifications:

The Eemann Tech Heavy Brass Feed Grip Plug is specifically designed for Glock Gen4 & Gen5 small frame standard size models such as G17, G22, G34, and G45.

It features an optimized feed ramp angle, designed to reduce split times during "Speed Reloads." Precision CNC machining ensures a perfect fit. The plug also prevents debris from entering the pistol through the frame cavity.

Approved for USPSA use, it offers a significant performance boost for competitive shooters and training professionals.

Material: High-quality brass

Weight: 72g



EEMANN TECH FRAME WEIGHT FOR GLOCK17 FRAME

Reference nr.

ET-120055

NEW

The Eemann Tech Frame Weight is designed for the GLOCK 17 frame to provide forward weight distribution, reducing muzzle rise and supporting better balance during shooting. Manufactured from durable carbon steel with a blackened finish, it mounts securely with two internal screws and requires no permanent modifications. The package includes a HEX key for straightforward installation.

Compatible with:

GLOCK 17 Gen3 / Gen4 / Gen5 or similar frames

Material: Carbon Steel

Color: Black





EEMANN TECH ALUMINIUM RED DOT MOUNT FOR GLOCK

Reference nr.	Type
ET-120041	V1
ET-120042	V2

Material: Aluminium Alloy 7075 T6

Weight: 15 g

Color: Black

Type V1 ET-120041 for:

- VORTEX VENOM
- VORTEX VIPER
- BURRIS FAST FIRE
- EOTECH MRDS
- SIG ROMEO 1
- VECTOR OPTICS SCRD-35
- VECTOR OPTICS SCRD-40
- The DOCTER®sight II plus

Type V2 ET-120042 for:

- C-MORE RTS2-ST2
- BENTLEY TSX6
- VORTEX RAZOR
- SIG SAUER ROMEO 3
- MEOPTA MEOSIGHT III
- MEOPTA MEORED
- TRIJICON RMR
- KAHLES HELIA RD 20018
- KAHLES HELIA RD 20019
- HOLOSUN HS507C
- HOLOSUN HE508T
- HOLOSUN HS407C



EEMANN TECH HOLOSUN 407K/507K ADAPTER FOR GLOCK MOS

Reference nr.
ET-120046



EEMANN TECH SHIELD RMS ADAPTER FOR GLOCK MOS

Reference nr.
ET-120047



EEMANN TECH ALUMINIUM RED DOT MOUNT FOR GLOCK

Reference nr.

ET-303135

Material: Aluminium Alloy 7075 T6

Weight: 15 g

Color: Black

Package contains:

- Aluminium Red Dot Mount for Glock - 1 pc.
Hex Socket Set Screw for Eemann Tech Red Dot Mount - already installed in the plate - 2 pcs.
Locator Pin V1C - ET-130881 - 2 pcs./set
- Spare screw and lock washer for Vortex Venom - ET-130888 - 2 pcs./set
- Adjustment Set Screw for Red Dot Mount - ET-130889 - 2 pcs./set

Compatible with:

- VORTEX VENOM or similar footprint red dots



EEMANN TECH HOLOSUN SCS 320 / LEUPOLD DP PRO ADAPTER FOR GLOCK MOS

Reference nr.

ET-120048



EEMANN TECH TRIJICON RMR ADAPTER FOR GLOCK MOS

Reference nr.

ET-120049



EEMANN TECH C-MORE RTS ADAPTER FOR GLOCK MOS

Reference nr.

ET-120052



EEMANN TECH VORTEX VENOM ADAPTER FOR GLOCK MOS

Reference nr.

ET-120053



EEMANN TECH FIRING PIN FOR GLOCK 9MM

Reference nr.

ET-122001



EEMANN TECH TRIGGER HOUSING PIN FOR GLOCK

Reference nr.

ET-122024



EEMANN TECH TRIGGER PIN FOR GLOCK

Reference nr.

ET-122018



EEMANN TECH LOCKING BLOCK PIN FOR GLOCK

Reference nr.

ET-122019

EEMANN TECH UPGRADE KIT FOR GLOCK GEN5*

**Reference nr.**

ET-120029

*Recommended only for OEM trigger system

The Eemann Tech Upgrade Kit for GLOCK Gen5 contains:

- ET-121003 - Eemann Tech GLOCK Firing Pin Spring (Reduced power) – Lightens trigger mechanism.
- ET-121020 - Eemann Tech Competition Trigger Spring for GLOCK Gen5 – Eases trigger pull.
- ET-121005 - Eemann Tech GLOCK Firing Pin Safety Spring (Reduced power) – Further lightens trigger mechanism.
- ET-122028 - Eemann Tech Competition Connector for GLOCK – 2.0 kg pull weight.
- ET-120031 - Eemann Tech Magazine Catch Extended for GLOCK GEN4/5 – Extends magazine release for faster reloads.

Disclaimer: Trigger safety may not function correctly with the full kit installed, as these are competition-grade springs.

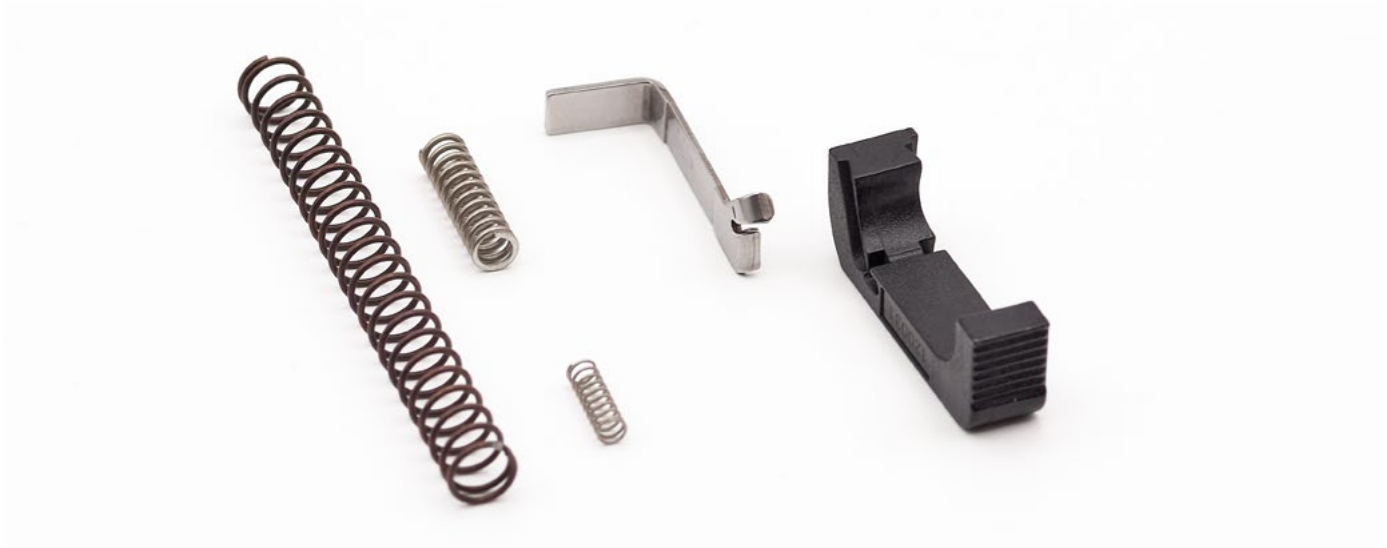



EEMANN TECH UPGRADE KIT FOR GLOCK GEN4*

Reference nr.

ET-120019

*Recommended only for OEM trigger system

Specifications:

- ET-121003 - Eemann Tech GLOCK Firing Pin Spring (Reduced Power)
- ET-121004 - Eemann Tech GLOCK Trigger Spring (Heavy)
- ET-121005 - Eemann Tech GLOCK Firing Pin Safety Spring (Reduced Power)
- ET-122028 - Eemann Tech Competition Connector for GLOCK - 2.0kg
- ET-120031 - Eemann Tech Magazine Catch Extended for GLOCK GEN4/5

Compatible with GLOCK GEN4 Small Frame

Trigger pull weight: ~2.5kg/~5.7 lbs (may vary)





EEMANN TECH UPGRADE KIT FOR GLOCK GEN3*

Reference nr.

ET-120020

*Recommended only for OEM trigger system

Kit Contains:

- ET-121003 - Eemann Tech GLOCK Firing Pin Spring (Reduced power) - This spring lightens the work of the trigger mechanism.
- ET-121004 - Eemann Tech GLOCK Trigger Spring (Heavy) - This spring helps you to pull the trigger easier.
- ET-121005 - Eemann Tech GLOCK Firing Pin Safety Spring (Reduced power) - This spring lightens the work of the trigger mechanism.
- 721 - GLOCK OEM Trigger Pull Connector 4,5 lbs. (2.0 kg).
- 1981 - GLOCK OEM Magazine Catch Extended for GLOCK GEN3 Small Frame.





EEMANN TECH UPPER PARTS KIT FOR GLOCK 9MM GEN 1-4

Reference nr.

ET-123940

Kit includes:

- Eemann Tech Firing Pin for GLOCK 9mm - 1pc.
- Eemann Tech Spacer Sleeve for GLOCK - 1pc.
- Eemann Tech Firing Pin Spring Cups for GLOCK - 1pc.
- Eemann Tech Channel Liner for GLOCK - 1pc.
- Eemann Tech Firing Pin Safety for GLOCK - 1pc.
- Eemann Tech Slide Cover Plate for GLOCK - 1pc.
- Eemann Tech Extractor Depressor Plunger Assembly for GLOCK 9mm - 1pc.
- Eemann Tech Firing Pin Safety Spring for GLOCK - 1pc.
- Eemann Tech Extractor for GLOCK 9mm - 1pc.
- Eemann Tech Firing Pin Spring 4 for GLOCK - 1pc.

VERY IMPORTANT – GUIDE ROD (Recoil Spring Assembly) and SIGHTS ARE NOT INCLUDED!

NB! This product is not manufactured, authorized, or warranted by GLOCK.



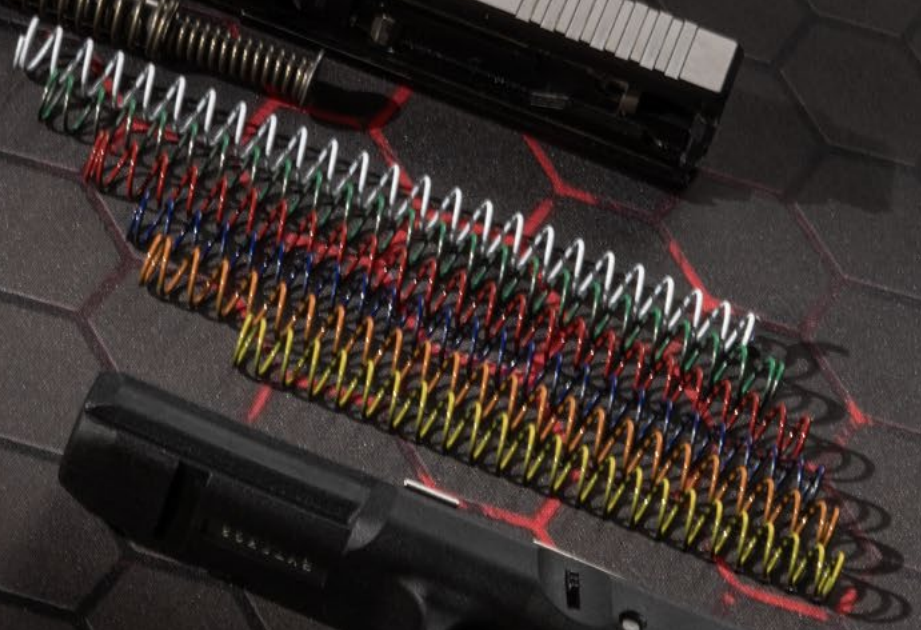

Eemann Tech Competition Recoil System for GLOCK

Reference nr.

ET-120015



Invented and produced for GLOCK17, 22, 34, 35 GEN5 models. GEN5 Recoil Spring Adapter and Installation Tool are included.



The set contains a recoil spring 13lbs. Recoil springs with other power values are available for purchasing separately (from 10lbs - 16lbs).



Recoil Spring Guide Rod is made from Carbon Steel with a maximum possible diameter for the best performance.



Eemann Tech Competition Recoil System for GLOCK

Reference nr.

ET-120016



Invented and produced for GLOCK19/23 GEN5. GEN5 Recoil Spring Adapter and Installation Tool are included.



The set contains a recoil spring 13lbs. Recoil springs with other power values are available for purchasing separately (from 10lbs - 16lbs).



Recoil Spring Guide Rod is made from Stainless Steel with a maximum possible diameter for the best performance.





EEMANN TECH COMPETITION RECOIL SYSTEM
FOR GLOCK 17-22 GEN5

Reference nr.	Color
ET-120015	Black



EEMANN TECH COMPETITION RECOIL SYSTEM
FOR GLOCK 19-23 GEN5

Reference nr.	Color
ET-120016	Black



EEMANN TECH COMPETITION GUIDE ROD FOR
GLOCK 17-22 GEN3/4

Reference nr.
ET-120032

NEW

EEMANN TECH COMPETITION GUIDE ROD FOR
GLOCK 19-23 GEN5

Reference nr.
ET-120017



EEMANN TECH COMPETITION GUIDE ROD FOR
GLOCK 17-22 GEN5

Reference nr.
ET-120011



EEMANN TECH COMPETITION GUIDE ROD
ADAPTER FOR GLOCK GEN4/5

Reference nr.
ET-120012



EEMANN TECH EXTRACTOR FOR GLOCK 9MM
GEN 3/4

Reference nr.

ET-122030



EEMANN TECH EXTRACTOR DEPRESSOR
PLUNGER ASSEMBLY FOR GLOCK 9MM

Reference nr.

ET-122025



EEMANN TECH TRIGGER HOUSING WITH EJECTOR
FOR GLOCK GEN3 9MM

Reference nr.

ET-122020



EEMANN TECH TRIGGER HOUSING FOR
GLOCK GEN3

Reference nr.

ET-122023



EEMANN TECH TRIGGER HOUSING WITH EJECTOR
FOR GLOCK GEN4 9MM

Reference nr.

ET-122031

NEW



ROME01

OPEN



EEMANN TECH TRIGGER WITH TRIGGER BAR
FOR GLOCK GEN3 9MM

Reference nr.

ET-122026



EEMANN TECH TRIGGER BAR FOR GLOCK
GEN3 9MM

Reference nr.

ET-122027



EEMANN TECH TRIGGER WITH TRIGGER BAR
FOR GLOCK GEN4 9MM

Reference nr.

ET-122040



EEMANN TECH EXTENDED SLIDE STOP
FOR GLOCK GEN3/4

Reference nr.

ET-122032



EEMANN TECH EXTENDED AMBI SLIDE STOP
FOR GLOCK GEN5

Reference nr.

ET-122249



EEMANN TECH COMPETITION CONNECTOR FOR GLOCK

Reference nr.

ET-122028



EEMANN TECH TRIGGER PULL CONNECTOR FOR GLOCK

Reference nr.

ET-122016



EEMANN TECH SLIDE LOCK FOR GLOCK

Reference nr.

ET-122015



EEMANN TECH EXTENDED SLIDE LOCK FOR GLOCK

Reference nr.

ET-122029



EEMANN TECH SLIDE COVER PLATE FOR GLOCK

Reference nr.

ET-122012



EEMANN TECH FIRING PIN SAFETY FOR GLOCK

Reference nr.

ET-122005



EEMANN TECH CHANNEL LINER FOR GLOCK

Reference nr.

ET-122004



EEMANN TECH SPACER SLEEVE FOR GLOCK

Reference nr.

ET-122002

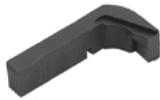

EEMANN TECH MAGAZINE CATCH EXTENDED FOR GLOCK GEN3

Reference nr.

ET-122021



EEMANN TECH MAGAZINE CATCH EXTENDED FOR GLOCK GEN4/5

Reference nr.

ET-120031



EEMANN TECH FIRING PIN SPRING CUPS FOR GLOCK

Reference nr.

ET-122003



EEMANN TECH LOCKING BLOCK FOR GLOCK17
GEN3

Reference nr.

ET-122036



EEMANN TECH LOCKING BLOCK FOR GLOCK17
GEN5

Reference nr.

ET-122035



EEMANN TECH FRAME INSERT PLUG FOR GLOCK
17 GEN 3

Reference nr.

ET-120061

NEW



EEMANN TECH FRAME INSERT PLUG
FOR GLOCK 17 GEN 4/5

Reference nr.

ET-120051



EEMANN TECH COMPETITION BUFFERS 5 PCS.
SET FOR GLOCK GEN 3

Reference nr.

ET-303012



EEMANN TECH EXTENDED BASE PAD FOR GLOCK
- 141MM

Reference nr.

ET-120033

NEW





EEMANN TECH SOLID SLIDE STOP FOR KMR

Reference nr.

ET-134750

Compatibility:

- OEM KMR SPECTRA slide stop

Material: Carbon Steel**Color:** Black**Purpose:** High-performance firearm accessory

EEMANN TECH THUMB REST SLIDE STOP FOR KMR

Reference nr.

ET-134520

Compatibility:

- KMR models

Material: Carbon steel**Total width:** approximately 44mm (1.73 inches)**Color:** Black

No firearm modification required

Special serrations for thumb placement

Extended rod for easy removal



EEMANN TECH RED DOT MOUNT KMRORV1 FOR KMR ARMS

Reference nr.

ET-134728

NEW

- ↳ ET-134728 - 1pc.
- ↳ ET-130881 - 2pc.
- ↳ ET-130882 - 2pc.
- ↳ ET-130883 - 2pc.
- ↳ ET-130888 - 2pc.
- ↳ ET-130891 - 2pc.
- ↳ ET-130890 - 2pc.
- ↳ ET-130897 - 2pc.

Type KMRORV1 for KMR Pistols - ET-134728 for:

- VORTEX VENOM
- VORTEX VIPER
- DOCTER
- SIG ROMEO 1
- SHIELD RMS/SMS
- VECTOR OPTICS SCRD-35
- VECTOR OPTICS SCRD-40
- VECTOR OPTICS SCRD-F19II



EEMANN TECH ULTIMATE TRIGGER FOR KMR GEN3

Reference nr.

ET-134752

NEW

EEMANN TECH ULTIMATE TRIGGER FOR KMR ARMS

Reference nr.

ET-134751







EEMANN TECH SLIDE STOP WITH THUMB REST FOR TANFOGLIO

Reference nr.	Color
ET-152002	Grey
ET-152000	Black

Compatible with:

- Tanfoglio Stock II
- Tanfoglio Stock III

Advantages:

- No firearm modification required
- No fitting required and instant installation
- Provides stability and consistent grip for recoil control
- Slide stop thumb rest functions as a normal slide stop allowing slide to lock back if required
- When installed, fits in the IPSC Standard gun box with OEM Safety.
- Legal in Standard and Open divisions
- Not legal in IPSC Production division

Installation:

Remove existing slide stop and replace with Eemann Tech slide stop with thumb rest

Total width: 41,5mm

Thumb rest width: 11mm

Weight: 13 g

Material: Carbon Steel



EEMANN TECH THUMB REST SLIDE STOP FOR TANFOGLIO - BLACK

Reference nr.

ET-150013

We are excited to present the Eemann Tech Thumb Rest Slide Stop designed for Tanfoglio pistols. This innovative accessory combines a thumb rest and slide stop into a single unit, crafted from high-quality carbon steel using CNC machining. It's engineered to provide superior ergonomics and fit comfortably with small to large hands. This dual-function component enhances grip stability and recoil control without any need for firearm modifications, and it fits within IPSC Standard and Open divisions.

Material: Steel**Color:** Black**Total Width:** ~44mm (~1.73")**Thumb Rest Width:** ~33mm (~1.29")

No firearm modification required

Compatible with Tanfoglio steel frame models

Installation involves replacing the existing slide stop





EEMANN TECH ULTIMATE TRIGGER FOR TANFOGLIO

Reference nr.	Color
ET-150010	Black
ET-150011	Silver



EEMANN TECH ULTIMATE STEEL TRIGGER FOR TANFOGLIO

Reference nr.
ET-150012



EEMANN TECH FLAT SA/DA TRIGGER FOR TANFOGLIO

Reference nr.	Color
ET-150004	Black
ET-150005	Silver



EEMANN TECH ADJUSTABLE REAR SIGHT FOR TANFOGLIO

Reference nr.
ET-150014

NEW

EEMANN TECH ALUMINIUM RED DOT MOUNT V1 FOR TANFOGLIO

Reference nr.
ET-152901

NEW



EEMANN TECH ALUMINIUM RED DOT MOUNT V2
FOR TANFOGLIO

Reference nr.

ET-152902



EEMANN TECH EXTENDED FIRING PIN
FOR TANFOGLIO - SMALL FRAME

Reference nr.

ET-152014



EEMANN TECH EXTENDED FIRING PIN
FOR TANFOGLIO - LARGE FRAME

Reference nr.

ET-152015



EEMANN TECH DISCONNECTOR PIN FOR
TANFOGLIO

Reference nr.

ET-150003



EEMANN TECH EXTRACTOR PIN FOR TANFOGLIO

Reference nr.

ET-152112

NEW



EEMANN TECH COMPETITION BUFFERS 5 PCS.
SET FOR TANFOGLIO

Reference nr.

ET-303015



EEMANN TECH LONG GUIDE ROD FOR TANFOGLIO

Reference nr.

ET-152012



EEMANN TECH SHORT GUIDE ROD FOR TANFOGLIO

Reference nr.

ET-152013



EEMANN TECH ULTIMATE DISCONNECTOR FOR TANFOGLIO

Reference nr.

ET-152030



EEMANN TECH COMPETITION DISCONNECTOR FOR TANFOGLIO

Reference nr.

ET-152010







EEMANN TECH COMPETITION GUIDE ROD FOR BERETTA 92

Reference nr.

ET-243001

The Eemann Tech Carbon Steel Blackened Guide Rod is engineered to provide flawless functionality with the recoil spring, ensuring optimal performance for your firearm. Designed with precision to match the ideal length for the slide, this guide rod is a perfect upgrade or replacement for your pistol. Compatible with a range of models including the 92x, 92 series, M9A3, and M9A1, it offers enhanced reliability for your shooting needs.

Model Compatibility:

- Beretta 92x
- Beretta 92 series
- Beretta M9A3
- Beretta M9A1

Material: Steel**Weight:** 30g**Color:** Black



EEMANN
TECH WWW.EEMANN.TECH





EEMANN TECH SLIDE STOP FOR PHOENIX

Reference nr.

ET-169137



EEMANN TECH SLIDE STOP THUMB REST FOR PHOENIX

Reference nr.

ET-169330



EEMANN TECH STEEL ULTIMATE TRIGGER FOR PHOENIX - BLACK

Reference nr.

ET-169700



EEMANN TECH ULTIMATE DISCONNECTOR FOR PHOENIX

Reference nr.

ET-169508



EEMANN TECH UPGRADE KIT FOR PHOENIX

Reference nr.

ET-169703

Specifications:

- Designed for: Drake and Redback models of Phoenix pistols
- Use: IPSC, USPSA & action shooting sports
- Legal in IPSC Production division
- Features competition springs for reduced trigger pull and slide reciprocation recoil
- Includes Ultimate Disconnecter and Trigger for ultra-short reset
- Requires no major modifications for installation

Components included:

- ET-169700 - Eemann Tech Ultimate Trigger for Phoenix - 1pc.
- ET-169011 - Eemann Tech Competition Trigger Spring for Phoenix - 1 pc.
- ET-169005 - Eemann Tech Recoil Spring for Phoenix - 11lbs - 1 pc.
- ET-169013 - Eemann Tech Competition Sear Spring for Phoenix - 1 pc.
- ET-169019 - Eemann Tech Competition Firing Pin Spring for Phoenix - 1 pc.
- ET-169508 - Eemann Tech Ultimate Disconnecter for Phoenix - 1pc.
- ET-169018 - Eemann Tech Main Spring for Phoenix 6 lbs - 1 pc. (Yellow color)
- ET-169017 - Eemann Tech Main Spring for Phoenix 7 lbs - 1 pc. (Red color)
- ET-030012 - Eemann Tech Hex Key 1,5mm L-Shaped - 1 pc.



Eemann Tech Aluminium Ultimate Long Grips for Phoenix Redback



Available in three sizes, these grips cater to a variety of hand sizes, ensuring a perfect fit. They are designed to fit all Phoenix models with steel frames, such as Drake and Redback, delivering excellent compatibility and performance.

Material: Aluminium

Set contains:

- 2 x Aluminium Ultimate Long Grips

Available sizes:

- Small: Thickness - 4.3mm
- Medium: Thickness - 6.4mm
- Large: Thickness - 7.9mm

Weight:

- Small: 22 gr (1pc) / 42gr (2pc)
- Medium: 28 gr (1pc) / 56gr (2pc)
- Large: 34 gr (1pc) / 68gr (2pc)



EEMANN TECH ALUMINIUM ULTIMATE GRIPS FOR PHOENIX REDBACK

Reference nr.	Size	
ET-169141	Small	NEW
ET-169142	Medium	NEW
ET-169143	Large	NEW





EEMANN TECH WALTHER PDP OR PLATE MOUNT
FOR VORTEX VENOM

Reference nr.

ET-249701

NEW



EEMANN TECH WALTHER PDP OR PLATE MOUNT
FOR C-MORE RTS

Reference nr.

ET-249702

NEW



EEMANN TECH WALTHER PDP OR PLATE MOUNT
FOR TRIJICON RMR/SRO / HOLOSUN 507COMP

Reference nr.

ET-249703

NEW



EEMANN TECH WALTHER PDP OR PLATE MOUNT
FOR SHIELD RMS

Reference nr.

ET-249705

NEW



EEMANN TECH WALTHER PDP OR PLATE MOUNT
FOR HOLOSUN 407K/507K

Reference nr.

ET-249706

NEW



EEMANN TECH TRIGGER HOUSING PIN FOR
WALTHER PDP/PPQ/Q4/Q5

Reference nr.

ET-249838

NEW



EEMANN TECH TRIGGER PIN FOR WALTHER PDP /
PPQ / Q4 / Q5

Reference nr.

ET-249458

NEW



ADC ITALY
SAFE FIRE



EEMANN TECH EJECTOR ROLL PIN FOR AR-15

Reference nr.

ET-180053

EEMANN TECH TAKEDOWN AND PIVOT PIN
DETENT FOR AR-15**Reference nr.**

ET-180038

EEMANN TECH TRIGGER GUARD ROLL PIN
FOR AR-15**Reference nr.**

ET-180039

EEMANN TECH TRIGGER AND HAMMER PIN
FOR AR-15**Reference nr.**

ET-180040



EEMANN TECH PIVOT PIN FOR AR-15

Reference nr.

ET-180036



EEMANN TECH TAKEDOWN PIN FOR AR-15

Reference nr.

ET-180037



EEMANN TECH FIRING PIN FOR AR-15

Reference nr.

ET-180059



EEMANN TECH FIRING PIN RETAINING PIN FOR AR-15

Reference nr.

ET-180060



EEMANN TECH GAS TUBE ROLL PIN FOR AR-15

Reference nr.

ET-180047



EEMANN TECH FORWARD ASSIST SPRING PIN FOR AR-15

Reference nr.

ET-180050



EEMANN TECH BOLT CATCH PIN FOR AR-15

Reference nr.

ET-180068



EEMANN TECH CAM PIN FOR AR-15

Reference nr.

ET-180061



EEMANN TECH EXTRACTOR PIN FOR AR-15

Reference nr.

ET-180055



EEMANN TECH 6-POSITION RECEIVER EXTENSION
TUBE FOR AR-15

Reference nr.

ET-180096

NEW



EEMANN TECH AR-15 COMPETITION AMBI
CHARGING HANDLE

Reference nr.

ET-180095

NEW



EEMANN TECH MAGAZINE CATCH BUTTON FOR AR-15

Reference nr.

ET-180074



EEMANN TECH EXTRACTOR FOR AR-15

Reference nr.

ET-180054



EEMANN TECH EXTRACTOR SPRING INSERT FOR AR-15

Reference nr.

ET-180057



EEMANN TECH EJECTOR FOR AR-15

Reference nr.

ET-180051



EEMANN TECH GAS TUBE FOR AR-15

Reference nr.

Length

ET-180041 38,5 cm (15 1/8 inch)

ET-180042 29,9 cm (11 3/4 inch)

ET-180043 24,8 cm (9 3/4 inch)



EEMANN TECH BOLT GAS RING KIT FOR AR-15 - 3 PCS. SET

Reference nr.

ET-180058

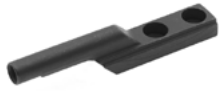

EEMANN TECH BOLT CARRIER KEY FOR AR-15

Reference nr.

ET-180062



EEMANN TECH CHARGING HANDLE ASSEMBLY FOR AR-15

Reference nr.

ET-180064



EEMANN TECH BOLT CATCH FOR AR-15

Reference nr.

ET-180067



EEMANN TECH MAGAZINE CATCH FOR AR-15

Reference nr.

ET-180069



EEMANN TECH FORWARD ASSIST ASSEMBLY FOR AR-15

Reference nr.

ET-180049



EEMANN TECH ADJUSTABLE .750 GAS BLOCK FOR AR-15

Reference nr.

ET-180094

NEW



EEMANN TECH DISCONNECTOR FOR AR-15

Reference nr.

ET-180070



EEMANN TECH HAMMER FOR AR-15

Reference nr.

ET-180065



EEMANN TECH TRIGGER FOR AR-15

Reference nr.

ET-180072



EEMANN TECH LOCKING NUT FOR AR-15

Reference nr.

ET-180076



EEMANN TECH END PLATE FOR AR-15

Reference nr.

ET-180077



EEMANN TECH MAGWELL FOR ADC M5 AR-15 RIFLES

Reference nr.

ET-180093



EEMANN TECH FIRING PIN FOR AR-9 PCC

Reference nr.

ET-189002



EEMANN TECH EXTRACTOR FOR AR-9 PCC

Reference nr.

ET-189001



EEMANN TECH SPACER WEIGHT FOR AR15/AR9

Reference nr.

ET-180092

ADC PCC



EEMANN TECH MAGWELL FOR ADC PCC GEN3 - BLACK

Reference nr.

ET-189004



EEMANN TECH MAGWELL FOR ADC PCC GEN3 - RED

Reference nr.

ET-189005

NEW



EEMANN TECH EXTENDED SAFETY SELECTOR FOR AK

Reference nr.

ET-188001

GRAND POWER



EEMANN TECH MAGWELL FOR GRAND POWER STRIBOG SR9

Reference nr.

ET-193001

JP GMR15 PCC



EEMANN TECH COMPETITION MAGWELL FOR JP GMR15 PCC

Reference nr.

ET-185001

NEW

JP JP5 PCC



EEMANN TECH COMPETITION MAGWELL FOR JP JP5 PCC

Reference nr.

ET-185002

NEW



FIRE
SAFE
GMN2010265
JP ENTERPRISES
HUGO, MN, USA
MODEL: GMR-1
CAL: 9MM

GMN2010265

JP
JP ENTERPRISES
PERFORMANCE FIREARMS

ET-18500





EEMANN TECH RECOIL SYSTEM FOR SIG SAUER P226

Reference nr.

ET-141020

Maximum available size of guide rod, possibility to change recoil spring on different power from 9 lbs - 13 lbs.

Best solution for competition and reloading ammunition.

Specification:

- Fits Sig Sauer P226
- Reduces recoil
- Quick and easy to install and remove without a gunsmith

Material: Carbon Steel, blued

Weight: 37g

Set includes:

- Steel, blued guide rod
- 13 lbs Eemann Tech Recoil Spring for Sig Sauer P226 - ET-141016

Note:

- Not legal in IPSC Production Division



EEMANN TECH COMPETITION GUIDE ROD FOR SIG SAUER P320 X5

Reference nr.

ET-145001

Maximum available size of guide rod, and possibility to change recoil spring for different power.

Best solution for competition and reloading ammunition.

Specification:

- Fits Sig Sauer P320 X5 and their models
- Adjustable recoil possibility
- Quick and easy to install and remove without a gunsmith

Material: Carbon steel, blued

Weight: 42g

Set includes:

- Steel, blackened guide rod



EEMANN TECH EXTRACTOR FOR SIGSAUER P226
X-SERIES

Reference nr.

ET-146919

NEW



EEMANN TECH COMPETITION MAGWELL FOR SIG
SAUER MPX

Reference nr.

ET-143001

NEW

SPARE SCREWS





SPARE SCREW 3MM FOR EEMANN TECH TRIGGERS FOR CZ

Reference nr.

ET-131003



SPARE SCREW 4MM FOR EEMANN TECH TRIGGERS FOR CZ

Reference nr.

ET-131004



SPARE SCREW 5MM FOR EEMANN TECH TRIGGERS FOR CZ

Reference nr.

ET-131002



SPARE SCREW FOR EEMANN TECH STANDARD BASE PAD FOR CZ

Reference nr.

ET-130893



SPARE BLADE SCREW FOR EEMANN TECH CZ ADJUSTABLE REAR SIGHT

Reference nr.

ET-131001



SPARE SCREW FOR EEMANN TECH ADJUSTABLE REAR SIGHT FOR CZ

Reference nr.

ET-131000



EEMANN TECH SPARE SCREW FOR CZ SHADOW 2
MAGAZINE CATCH BUTTON

Reference nr.

ET-130898



EEMANN TECH GRIP SCREWS FOR CZ /
TANFOGLIO - 2 PCS./SET

Reference nr.

ET-130894

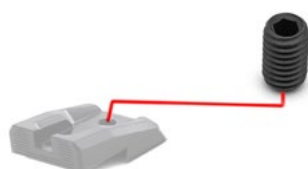

EEMANN TECH EXTENDED SCREW FOR
CZ 75 SP-01 OEM REAR FIXED SIGHT

Reference nr.

ET-012024



SPARE SCREW FOR EEMANN TECH MAGWELL
FOR CZ 75 SP-01/CZ TS/CZ TS2

Reference nr.

ET-131010



SPARE SCREW FOR EEMANN TECH MAGWELL
FOR CZ SHADOW 2

Reference nr.

ET-131008



EEMANN TECH SPARE SCREW FOR CZ OR PLATE
MOUNT - 2 PCS./SET

Reference nr.

ET-130896



EEMANN TECH SPARE SCREW
FOR CZ GRIPS - 2 PCS./SET

Reference nr.

ET-130895



SPARE SCREW FOR EEMANN TECH MAGAZINE
CATCH WITH EXTENDED BUTTON FOR 1911/2011

Reference nr.	Color
ET-111099	Black
ET-111098	Silver



EEMANN TECH SPARE SCREW FOR 1911/2011 TWO
PIECES MAGWELL

Reference nr.	Color
ET-111186*	Black
ET-111183**	Silver

* for ET-111180

** for ET-111181



EEMANN TECH GRIP SCREW BUSHING FOR 1911

Reference nr.	Height	Color
ET-111250	4,0 mm	Black
ET-111251	4,0 mm	Silver
ET-111252	6,9 mm	Black
ET-111253	6,9 mm	Silver



EEMANN TECH TORX GRIP SCREWS FOR 1911 (SET OF 4) - SILVER

Reference nr.

ET-111003

NEW



EEMANN TECH TORX GRIP SCREWS FOR 1911 (SET OF 4) - BLACK

Reference nr.

ET-111004

NEW



EEMANN TECH TORX GRIP SCREWS FOR 1911 (SET OF 4) - GOLD

Reference nr.

ET-111005

NEW







SPARE SCREW FOR EEMANN TECH FIXED REAR
SIGHT FOR GLOCK

Reference nr.

ET-121002



SPARE SCREW FOR EEMANN TECH ADJUSTABLE
GLOCK REAR SIGHT

Reference nr.

ET-121001



SPARE SCREW FOR EEMANN TECH GLOCK
FRONT SIGHT

Reference nr.

ET-121000



SPARE SCREW EEMANN TECH FOR HEAVY BRASS
FEED GRIP - BLACK

Reference nr.

ET-120058





SPARE SCREW FOR EEMANN TECH TRIGGERS
FOR KMR ARMS

Reference nr.

ET-131006



EEMANN TECH SPARE SCREW FOR KMR OR PLATE
MOUNT - 2 PCS./SET

Reference nr.

ET-130897





EEMANN TECH PISTOL GRIP SCREW FOR AR-15

Reference nr.

ET-180033



EEMANN TECH BOLT CARRIER KEY SCREW FOR AR-15

Reference nr.

ET-180063



JP PCC



SPARE SCREW FOR EEMANN TECH MAGWELL FOR JP PCC

Reference nr.

ET-131009

NEW

A close-up photograph of a black metal tool, likely a high-speed steel drill bit. The tool features a central cutting edge and a series of longitudinal grooves. A black metal collar is attached to the tool, featuring a logo and the website address "WWW.EEMANN.TECH". The background is a light-colored, textured surface.

WWW.EEMANN.TECH



EEMANN TECH SPARE SCREW T15 FOR RED DOT MOUNT V1 - 2 PCS./SET

Reference nr.

ET-130891



ADJUSTMENT SET SCREW FOR EEMANN TECH RED DOT MOUNT - 2 PCS./SET

Reference nr.

ET-130889



EEMANN TECH SPARE SCREW AND LOCK WASHER FOR VORTEX VENOM - 2 PCS./SET

Reference nr.

ET-130888



EEMANN TECH SPARE SCREW M4X10 FOR RED DOT MOUNT V2- 2 PCS./SET

Reference nr.

ET-130890



SPARE SCREW FOR EEMANN TECH RED DOT MOUNT FOR HOLOSUN 407K/507K - 2 PCS./SET

Reference nr.

ET-130879

NEW



EEMANN TECH SPARE SCREW M4X12 FOR RED DOT MOUNT V2- 2 PCS./SET

Reference nr.

ET-130892



HEX SOCKET SET SLIDE LOCK SCREW FOR EEMANN TECH RED DOT MOUNT V1 - 2 PCS./SET

Reference nr.

ET-130880



HEX SOCKET SLIDE LOCK SCREW FOR EEMANN TECH RED DOT MOUNT V2 - 2 PCS./SET

Reference nr.

ET-130887



SPARE SCREW FOR EEMANN TECH RED DOT MOUNT FOR TRIJICON RMR/SRO - 2 PCS./SET

Reference nr.

ET-130179

VR TRAINING





Eemann Tech Serrated Plastic Grips for CZ Shadow 2 Compact



The Eemann Tech Dummy Plastic Grips for CZ Shadow 2 Compact are made from high-quality 3D filament, ensuring durability and a sharp-textured surface for a secure grip.

Material:

High-quality 3D filament

Color options:

Black, Blue

Compatible with: real CZ Shadow 2 Compact and the Eemann Tech AceVR headset for CZ frames.



EEMANN TECH CZ SHADOW 2 FRAME FOR ACE XR
META QUEST 3

Reference nr.

ET-603202

NEW



EEMANN TECH G17 FRAME FOR ACE XR META
QUEST 3

Reference nr.

ET-603203

NEW



EEMANN TECH CZ SHADOW 2 COMPACT FRAME
FOR ACE XR META QUEST 3

Reference nr.

ET-603204

NEW



EEMANN TECH WALTHER PDP FRAME FOR ACE XR
META QUEST 3

Reference nr.

ET-603205

NEW



EEMANN TECH WALTHER PDP SF FRAME FOR ACE
XR META QUEST 3

Reference nr.

ET-603206

NEW



EEMANN TECH BERETTA 92X FRAME FOR ACE XR
META QUEST 3

Reference nr.

ET-603207

NEW



EEMANN TECH ALIEN CREATOR FRAME FOR ACE
XR META QUEST 3

Reference nr.

ET-603208

NEW



EEMANN TECH 3D SERRATED PLASTIC GRIPS FOR CZ SHADOW 2 COMPACT - BLUE

Reference nr.	Color	
ET-130265	Blue	NEW



EEMANN TECH 3D SERRATED PLASTIC GRIPS FOR CZ SHADOW 2 COMPACT - BLACK

Reference nr.	Color	
ET-130266	Black	NEW



EEMANN TECH TRIGGER ASSEMBLY FOR 3D
GLOCK17 FRAME ACE XR HEADSET

Reference nr.

ET-603021

NEW



EEMANN TECH ULTIMATE TRIGGER ASSEMBLY
FOR 3D CZ SHADOW 2 FRAME ACE XR HEADSET

Reference nr.

ET-603019

NEW



EEMANN TECH TRIGGER ASSEMBLY FOR 3D
BERETTA 92X FRAME ACE XR HEADSET

Reference nr.

ET-603030

NEW



EEMANN TECH MAGAZINE CATCH FOR 3D
GLOCK17 FRAME ACE XR HEADSET

Reference nr.

ET-603010

NEW



EEMANN TECH MAGAZINE CATCH FOR 3D
BERETTA 92X FRAME ACE XR HEADSET

Reference nr.

ET-603031

NEW



EEMANN TECH 3D HANDSET PIN FOR 3D VR
FRAMES 2 PCS./SET

Reference nr.

ET-603101

NEW



A close-up, diagonal view of the edge of a cardboard target. The image shows the layered structure of the cardboard, with a dark grey background on the left and a light tan background on the right. The text is overlaid on the dark grey area.

Eemann Tech produces **different kinds of targets** for practical and other action shooting disciplines. The selection of Eemann Tech targets covers IPSC, IDPA, USPSA, ISSF, Target Shooting and tactical disciplines.

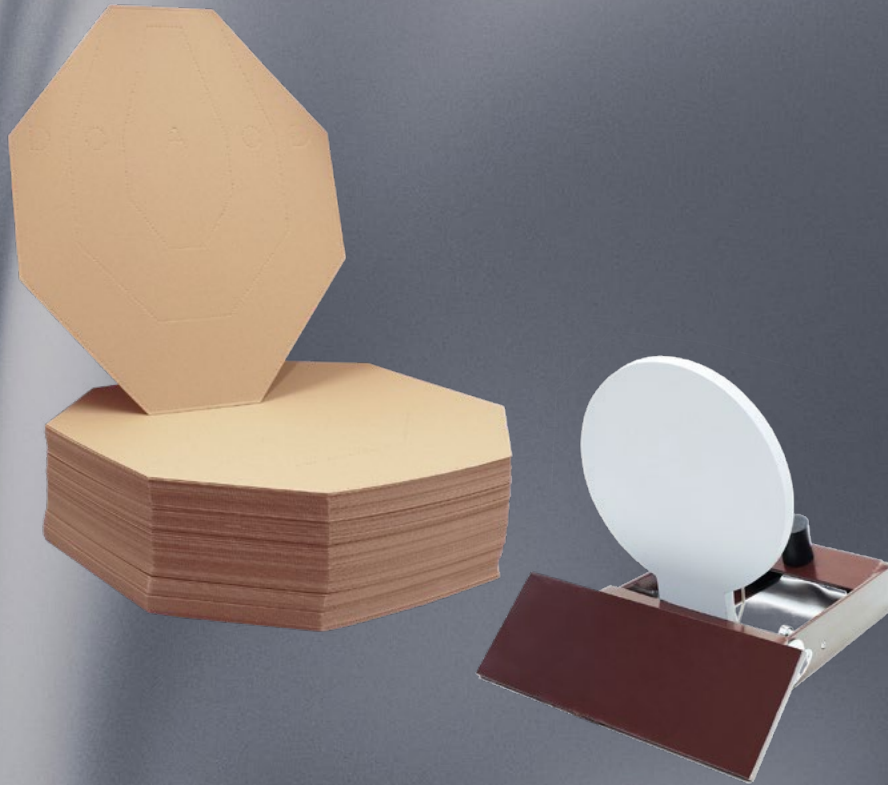

Cardboard targets are the “expendable material” for any kind of competition from Level I to World Shoots, Club team practices, individual training, and master classes. You can never have enough targets! Eemann Tech Company produces cardboard and paper targets for indoor shooting galleries and open-air shooting ranges.

In addition to the target selection Eemann Tech offers different types of target patches.

Our patches are made of water- and frost-resistant material. Specially designed for the IPSC/IDPA and their type of targets. The 20 mm patches are meant for patching hits from handgun, rifle shots or shotgun buckshots. The 30 mm patches are meant for rifle shots starting from caliber 7.62 mm. The 40 mm patches are meant for patching hits from shotgun slugs. The range of Eemann Tech patches have a wide selection of colors, diameter and quantity per roll.

Besides the paper and cardboarded targets Eemann Tech has a selection of Self Setting Metal Plate Targets. The Self Setting Targets are made of HARDOX steel and are intended for competition and shooting practice with handgun or rifle.

All products manufactured by Eemann Tech are labelled and have original packaging.

TARGETS & PATCHES



Eemann Tech Self Setting Steel
Target, HARDOX, 200 mm

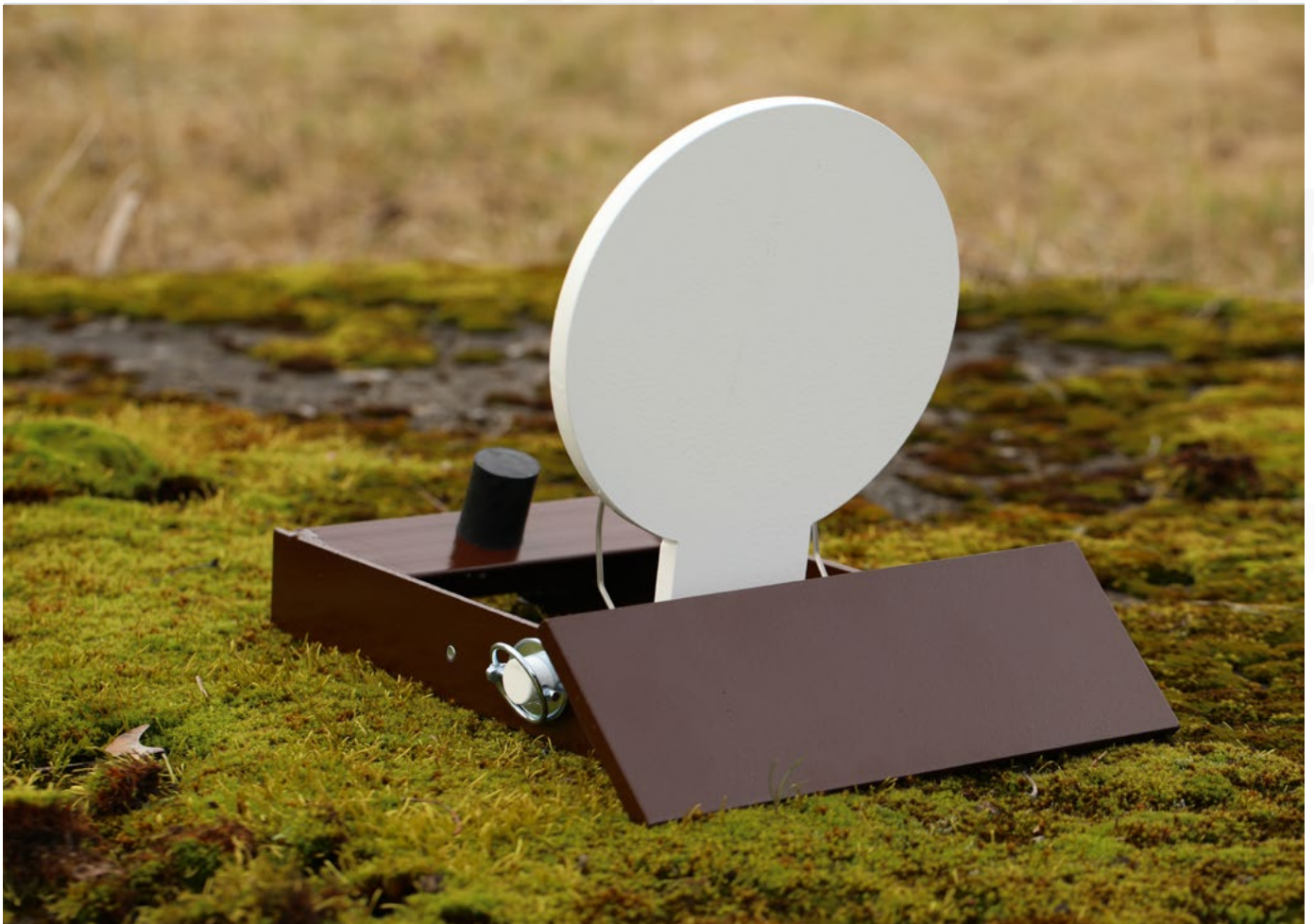

Taking **training** to the next level

THE EEMANN TECH SELF SETTING STEEL TARGET, HARDOX, 200 MM

Reference nr.

ET-040012

Technical Specifications

- Plate material: HARDOX 450 (plate)
- Plate thickness: 12 mm
- Plate diameter: 20 cm
- Height: 28 cm
- Weight: 9 kg

Set Contains

- Eemann Tech IPSC Self Setting HARDOX Steel Target
- 2-springs-set [ET-040010]
- Additional 2-springs-set with reduced power -10% [ET-040011]

Target Has Been Tested By

- Pistol at 7 meters distance (calibers: 9×19; 7,62×25; .38 SUPER)
- Rifle at 100 meters distance (calibers: .223 REM; 7,62×39; .308 WIN; 7,62×54R)



Steel Targets

The Eemann Tech IPSC Self Setting HARDOX Steel Target made of HARDOX steel for competition and practice shooting using handgun or rifle.

The plate rises by means of special springs that can be easily removed if needed. The speed and rigidity of rising the plate backwards depends on springs power.

To maximize the training effect and have the plate rise back again to the standing position after each shot the plate should be used as it was designed with springs set mounted. To satisfy shooters with different firearm power factor the self setting plate set contains different power springs to provide the option for customization, to meet your needs and expectations. Using the Eemann Tech Self Setting Steel Target will take training to the next level!

To use the plate for IPSC competitions the springs can be easily removed and the plate will work as a normal falling plate.

The self setting plate has a heavy base made of steel that keeps the plate in place whilst shooting. To fix the plate in place reliably the special holes are perforated on the horizontal parts of the plate base. Using the securing holes, the plate can be either fixed on the ground in the vertical position or secured to some stable construction downwards.



SELF SETTING STEEL TARGET, HARDOX, 200 MM

Reference nr.

ET-040012



SPARE PLATE FOR SELF SETTING STEEL TARGET
200 MM X 12 MM, HARDOX

Reference nr.

ET-040013



SPARE ASSEMBLY KIT FOR SELF SETTING STEEL
TARGET

Reference nr.

ET-040014



SPARE SPRING SET FOR SELF SETTING STEEL
TARGET

Reference nr.

ET-040010



SPARE SPRING SET FOR SELF SETTING STEEL
TARGET, REDUCED POWER -10%

Reference nr.

ET-040011



EEMANN TECH SPARE LYNCH PINS SET
FOR SELF SETTING TARGET

Reference nr.

ET-040016

EEMANN TECH IPSC MINI POPPER

Reference nr.

ET-040020

Technical Specifications

- Popper material: Steel S355
- Mounting base material: Steel S355
- Popper thickness: 10 mm
- Popper diameter: 200 mm
- Height: 55 cm
- Nett Weight: 11.9 kg
- Gross Weight: 12.5 kg



Set Contains

- 1 x Eemann Tech IPSC Mini Steel Popper
- 1 x Adjusting Bolt
- 1 x IPSC Mini Popper Assembly Kit ET-040014

Mini Popper

The Eemann Tech IPSC Mini Popper is made of steel and designed to be stable when using it on a hard surface, on the ground, or in indoor shooting ranges. It can be used for IPSC, USPSA and IDPA for both handgun and shotgun competitions and training. Not recommended for rifle.

The IPSC Mini Popper has a heavy mounting base made of steel that keeps the popper in place while shooting.

The popper can be secured to a stable structure or to the floor using the securing holes provided in the frame if required.





Eemann Tech Cardboard IPSC
Target, TAN/WHITE, 100pcs



- Cardboard paper targets
- Thickness 1.2 mm
- One-side perforated

Train your shooting **accuracy**
to be perfect

CARDBOARD IPSC TARGET



Reference nr.	Color	Quantity
ET-202100	TAN / WHITE	100 pcs

*Target's size is original size from IPSC rulebook (Appendix B2)

CARDBOARD IPSC MINI TARGET



Reference nr.	Color	Quantity
ET-213100	TAN / WHITE	100 pcs

*Target's size is 60% from Cardboard IPSC Target ET-202100

CARDBOARD IPSC MICRO TARGET

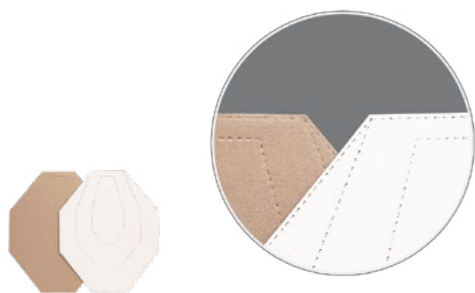

Reference nr.	Color	Quantity
ET-223100	TAN / WHITE	100 pcs

*Target's size is 40% from Cardboard IPSC Target ET-202100

CARDBOARD IDPA TARGET

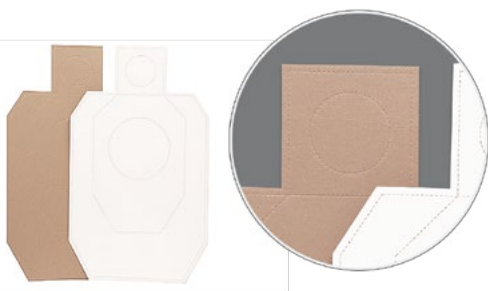

Reference nr.	Color	Quantity
ET-231100	TAN / WHITE	100 pcs

High quality IPSC legal targets for competition and training needs.

Perforated to include A, C, and D zones.

Perforation on Tan/White targets is done on the front side of target (Tan side). White side can be used both as Penalty Target and Scoring Target (perforation of scoring lines on white side is visible).

Material: Cardboard

Available quantity per pack: 100 pcs.

Color: Tan/White

Packaging: Transparent Stretch Wrap



CARDBOARD METRIC TARGET

Reference nr.	Color	Quantity
ET-239100	TAN / WHITE	100 pcs



CARDBOARD ALTERNATIVE IDPA TARGET

Reference nr.	Color	Quantity
ET-232100	TAN / WHITE	100 pcs

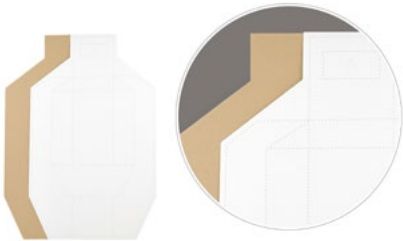

CARDBOARD TACTICAL TARGET

Reference nr.	Color	Quantity
ET-224100	TAN / WHITE	100 pcs



CARDBOARD IPSC PAINTED TARGET

Reference nr.	Color	Quantity
ET-202950	TAN / WHITE	50 pcs



WATERPROOF IPSC TARGET

Reference nr.	Color	Quantity
ET-203050	TAN / WHITE	50 pcs



IPSC VERTICAL PAINTED TARGET

Reference nr.	Color	Quantity
ET-202350	TAN+BLACK/WHITE	50 pcs



WATERPROOF IDPA TARGET

Reference nr.	Color	Quantity
ET-234050	TAN / WHITE	50 pcs

Elevate your shooting with high-quality waterproof IDPA targets designed for rainy weather competitions and training. Made from durable 1mm MDF cardboard, these targets are fully lacquered for waterproofing and perforated to delineate 0, -1, and -3 zones. Each target comes in a tan/white color scheme, with perforations on the tan side, while the white side can serve as both a penalty or scoring target. Each pack weighs around 11 kg and includes 50 targets, making it a reliable option for large-scale shooting events.

Material: 1mm MDF cardboard

Quantity per pack: 50 pcs.

Quantity per pallet: ~60 packs

Colors: Tan/White

Weight: ~11 kg per pack

Perforation zones: 0, -1, -3 (visible on tan and white sides)



CARDBOARD METRIC TARGET

Reference nr.	Color	Quantity
ET-239100	TAN / WHITE	100 pcs



EEMANN TECH IPSC CUT PAPER TARGETS – 100 PCS./PACK

Reference nr.	Color	Quantity	
ET-202470	TAN / WHITE	100 pcs	NEW

The Eemann Tech IPSC Cut Paper Targets are high-quality, IPSC-compliant targets designed for precision training and official competition use. Each target is cut and perforated to display A, C, and D scoring zones in accordance with IPSC target array book. The front tan side contains clear scoring perforations, while the white reverse side can be used as a Penalty or Scoring Target. This pack is perfect for realistic stage simulations and ipsc competitions..

Material: High-quality cardboard

Quantity per pack: 25+25+50=100 pcs.

Quantity per pallet: 80 packs

Colors: Tan (front) / White (back)

Weight: ~11 kg per pack

Perforation zones: A, C, D



CARDBOARD IPSC TARGET WHITE/RED - 100 PCS./PACK

Reference nr.	Color	Quantity	
ET-204100	WHITE / RED	100 pcs	NEW



Eemann Tech Paper Target
Patches Roll



Giving a second **life** to targets



EEMANN TECH PAPER TARGET PATCH ROLL TAN

Reference nr.	Diameter	Quantity per roll
ET-302023	14 mm	1000 pcs
ET-302001	20 mm	1000 pcs
ET-302002	20 mm	2000 pcs
ET-302014	20 mm	3000 pcs
ET-302003	30 mm	1000 pcs
ET-302004	40 mm	1000 pcs



EEMANN TECH PAPER TARGET PATCH ROLL WHITE

Reference nr.	Diameter	Quantity per roll
ET-302024	14 mm	1000 pcs
ET-302005	20 mm	1000 pcs
ET-302017	20 mm	2000 pcs
ET-302006	30 mm	1000 pcs
ET-302007	40 mm	1000 pcs



EEMANN TECH PAPER TARGET PATCH ROLL BLACK

Reference nr.	Diameter	Quantity per roll
ET-302025	14 mm	1000 pcs
ET-302008	20 mm	1000 pcs
ET-302018	20 mm	2000 pcs
ET-302009	30 mm	1000 pcs
ET-302010	40 mm	1000 pcs



EEMANN TECH PAPER TARGET PATCH ROLL GREEN

Reference nr.	Diameter	Quantity per roll
ET-302026	14 mm	1000 pcs
ET-302011	20 mm	1000 pcs
ET-302019	20 mm	2000 pcs
ET-302012	30 mm	1000 pcs
ET-302013	40 mm	1000 pcs



EEMANN TECH PAPER TARGET PATCH ROLL RED

Reference nr.	Diameter	Quantity per roll
ET-302015	20 mm	1000 pcs
ET-302016	40 mm	1000 pcs

EEMANN TECH TARGET PATCHES ORGANIZER



Reference nr.	Color	
ET-302021	Black	NEW
ET-302022	Red	NEW



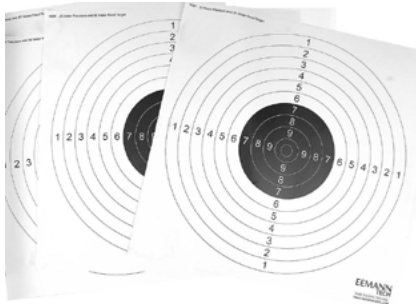

THE EEMANN TECH ISSF 25M TARGET 550 MM X 550 MM

Reference nr.

ET-222100

Eemann Tech ISSF 25M Precision & 50M Pistol Target for:

- 50 m Pistol
- 25 m Standard Pistol events
- 25 m Center Fire precision stage
- 25 m Pistol events

Available quantity per pack: 100pcs.

Inner ten: 25 mm (± 0.2 mm)

Black from 7 to 10 rings = 200 mm (± 1.0 mm)

Ring thickness: 0.2 mm to 0.5 mm

Size: 550 mm x 550 mm

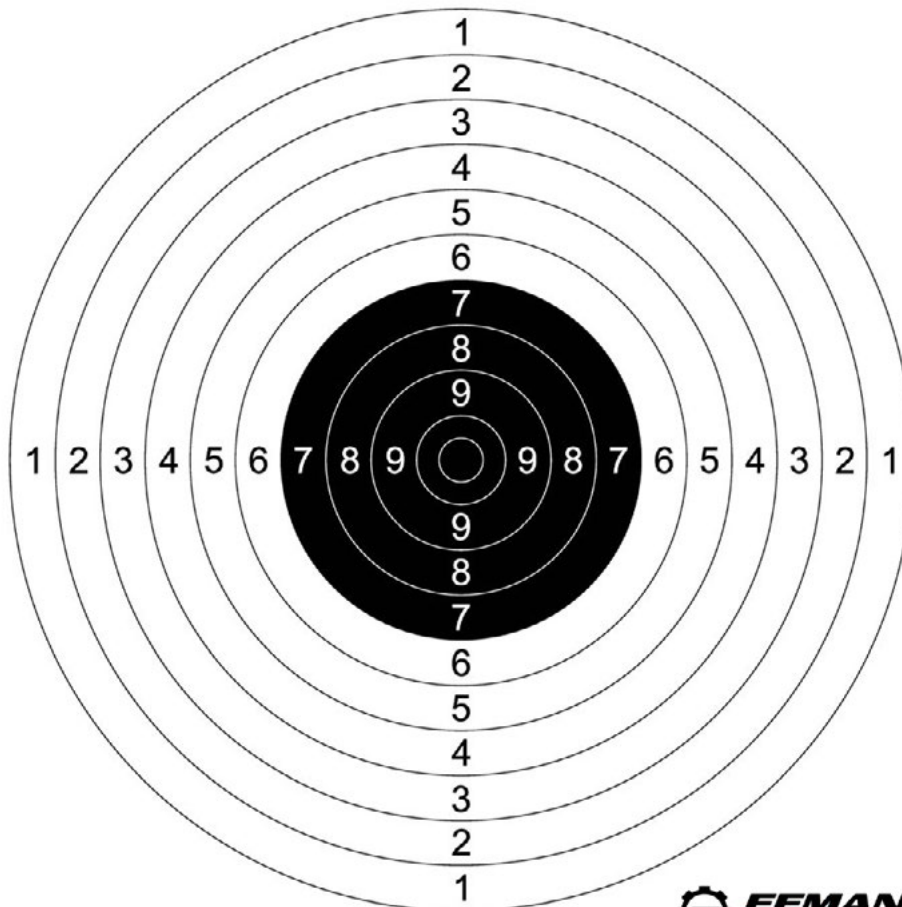

Practice makes perfect



EEMANN TECH IPSC DRY FIRING TRAINING KIT

Reference nr.

ET-222101



EEMANN TECH USPSA DRY FIRING TRAINING KIT

Reference nr.

ET-222102



EEMANN TECH IDPA DRY FIRING TRAINING KIT

Reference nr.

ET-222103



The Eemann Tech Dry Firing Targets Kit is specially made for home dry fire training exercises. The targets are laser cut products made of 2 mm thick MDF and have A, C and D zones clearly marked.

Each target has a hole on the top part for attaching purposes onto any soft surfaces by tacs (included). The holes located on the target's sides are meant for rotation imitation. Cut targets represent hard cover targets.

The Targets Have 3 Sizes

- Large targets: 15 cm tall that are 26 % of full-size target and imitate medium distance
- Medium targets: 9 cm tall that are 16 % of full-size target and imitate long distance
- Small targets: 6 cm tall that are 10 % of full-size target and imitate very long distance

Color

- Targets are of TAN color
- Poppers are of WHITE color





TOOLS & CLEANING



EEMANN TECH GUN BORE ROPE CLEANER

Reference nr.	Caliber
ET-030023	9×19 mm
ET-030024	.223 Rem
ET-030025	.308 Win
ET-030026	.40 S&W
ET-030027	12 Gauge
ET-030028	.45AUTO
ET-030029	.22LR
ET-030031	.177 (4.5 mm)



EEMANN TECH TORX KEY T15 L-SHAPED

Reference nr.
ET-030011



EEMANN TECH TORX KEY T20 L-SHAPED

Reference nr.
ET-030010



EEMANN TECH HEX KEY 1,5MM L-SHAPED

Reference nr.
ET-030012



EEMANN TECH HEX KEY 2MM L-SHAPED

Reference nr.
ET-030013



EEMANN TECH HEX KEY 2,5MM L-SHAPED

Reference nr.
ET-030014



EEMANN TECH HEX KEY 3MM L-SHAPED

Reference nr.

ET-030015

NEW



EEMANN TECH HSS DRILL FOR THE CZ FRONT SIGHT

Reference nr.

ET-020002



EEMANN TECH DIAMOND FILES 10-PCS SET

Reference nr.

ET-030009



EEMANN TECH IPSC SCORING HANDGUN OVERLAY

Reference nr.

ET-030030



EEMANN TECH PISTOL AMMO CHAMBER CHECKER

Reference nr.

Caliber

ET-030020

9×19 mm

ET-030021

.40 S&W

ET-030022

.45AUTO

.45auto .40S&W 9×19 mm

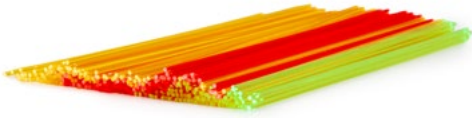

EEMANN TECH REPLACEMENT FIBER RODS – DEALER PACK (100 PCS)

Reference nr.	Color	Diameter	
ET-009101	Red	1 mm	NEW
ET-009104	Green	1 mm	NEW
ET-009107	Yellow	1 mm	NEW
ET-009102	Red	1,5 mm	NEW
ET-009105	Green	1,5 mm	NEW
ET-009108	Yellow	1,5 mm	NEW
ET-009103	Red	2 mm	NEW
ET-009106	Green	2 mm	NEW
ET-009109	Yellow	2 mm	NEW



EEMANN TECH REPLACEMENT FIBER ROD - 2PCS./SET

Reference nr.	Color	Diameter
ET-031010	Red	1 mm
ET-032010	Green	1 mm
ET-033010	Yellow	1 mm
ET-031015	Red	1,5 mm
ET-032015	Green	1,5 mm
ET-033015	Yellow	1,5 mm
ET-031020	Red	2 mm
ET-032020	Green	2 mm
ET-033020	Yellow	2 mm



EEMANN TECH GRIP TAPE 5 CM X 30 CM

Reference nr.	Pistol model
ET-303001	Black
ET-303002	Blue
ET-303005	Red
ET-303007	Grey

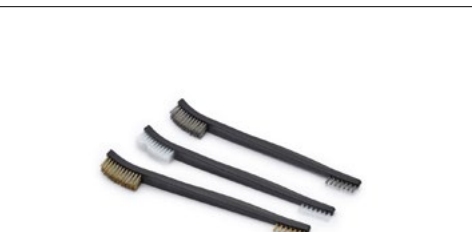

EEMANN TECH DOUBLE END CLEANING BRUSH - 3PCS./KIT

Reference nr.
ET-030043



EEMANN TECH UNIVERSAL GRIP TAPE FOR
MAGAZINE BASE PADS – 5 PCS./PACK

Reference nr.

ET-030008

NEW



EEMANN TECH NUMBERED GRIP TAPE SET FOR
MAGAZINE BASE PADS - 10 PCS

Reference nr.

ET-030051

NEW



EEMANN TECH BRASS SQUIB ROD

Reference nr.

ET-030039



EEMANN TECH INSTALLATION TOOL FOR ET
GUIDE RODS

Reference nr.

ET-120010



EEMANN TECH 4-PCS PLASTIC HOOK SET

Reference nr.

ET-030100

**EEMANN TECH SLIDE LOCK TOOL FOR CZ****Reference nr.**

ET-030332

**EEMANN TECH SLIDE LOCK TOOL FOR 1911/2011****Reference nr.**

ET-030333

**EEMANN TECH SLIDE LOCK TOOL FOR GLOCK****Reference nr.**

ET-030334

**EEMANN TECH SLIDE LOCK TOOL FOR
SIG SAUER P320****Reference nr.**

ET-030335

**EEMANN TECH SLIDE LOCK TOOL FOR CZ P-10****Reference nr.**

ET-030336



EEMANN TECH SLIDE LOCK TOOL FOR TANFOGLIO

Reference nr.

ET-030337



EEMANN TECH SLIDE LOCK TOOL FOR WALTHER PPQ/PDP

Reference nr.

ET-030338



EEMANN TECH SLIDE LOCK TOOL FOR BERETTA 92/92X

Reference nr.

ET-030339



EEMANN TECH SLIDE LOCK TOOL FOR KMR

Reference nr.

ET-030331



EEMANN TECH VISE BLOCK TOOL FOR GLOCK PCC MAGAZINES

Reference nr.

ET-030080

NEW



EEMANN TECH BENCH BLOCK FOR CZ SHADOW 2

Reference nr.

ET-030076

NEW



EEMANN TECH GUNSMITH BENCH BLOCK FOR GLOCK FRAME

Reference nr.

ET-120059

NEW



EEMANN TECH GUNSMITH BENCH BLOCK FOR CZ P-10 FRAMES

Reference nr.

ET-030067

NEW



EEMANN TECH BENCH BLOCK FOR WALTHER PDP/
PDP SF FRAME

Reference nr.

ET-030052

NEW



EEMANN TECH UNIVERSAL GUNSMITH BENCH
BLOCK

Reference nr.

ET-301855

NEW



EEMANN TECH INSTALLATION TOOL FOR CZ
BARREL BUSHINGS

Reference nr.

ET-030068

NEW



EEMANN TECH BUSHING TOOL FOR KMR PISTOLS

Reference nr.

ET-134501

NEW



EEMANN TECH AR15 / M4 WRENCH MULTI BARREL
NUT SPANNER TOOL

Reference nr.

ET-030108

NEW



EEMANN TECH IPSC MEASUREMENTS GAUGE

Reference nr.

ET-009226

NEW



EEMANN TECH RISER ADAPTER 15MM HEIGHT 5
SLOTS QUICK RELEASE

Reference nr.

ET-030004

NEW



EEMANN TECH 1911 BUSHING WRENCH

Reference nr.

ET-030110

NEW



EEMANN TECH SAFETY CHAMBER FLAG FOR HANDGUN/PCC/RIFLE

Reference nr.

ET-030003

NEW



EEMANN TECH ELASTIC PISTOL DUST COVER

Reference nr.

ET-030033

NEW



EEMANN TECH AMMO BOX 50 ROUNDS 9X19MM

Reference nr.

ET-030046

NEW



EEMANN TECH GLOCK FRONT SIGHT TOOL

Reference nr.

ET-030109

NEW

**EEMANN TECH GUNSMITH'S PUNCH SET - 4PCS.****Reference nr.**

ET-030107

NEW**EEMANN TECH GUNSMITHING PIN PUNCH - 3MM****Reference nr.**

ET-030104

NEW**EEMANN TECH GUNSMITHING PIN PUNCH - 2.5MM****Reference nr.**

ET-030103

NEW**EEMANN TECH GUNSMITHING PIN PUNCH - 2MM****Reference nr.**

ET-030102

NEW**EEMANN TECH GUNSMITHING PIN PUNCH - 1.5MM****Reference nr.**

ET-030101

NEW



EEMANN TECH SEAR SPRING INSTALLATION
TOOL FOR CZ

Reference nr.

ET-130067



EEMANN TECH DOVETAIL FRONT SIGHT
INSTALLATION TOOL

Reference nr.

ET-111002



EEMANN TECH SEAR SPRING INSTALLATION
TOOL FOR TANFOGLIO

Reference nr.

ET-150007



MADE IN
CZECH REPUBLIC, CZ



EEMANN TECH CORN COB POLISHING MEDIA
M16 - 2 KG

Reference nr.

ET-030032

High quality corn cob media which can remove grit, dirt and powder residue from your cases.

The media can be used repeatedly but should be replaced periodically for the best result. The small grain media is perfect for use in small to medium size tumblers and cleans even the smallest recesses of case rims and primer pockets.

Works great with all polishing additives. Just a few spoons onto the media and then a few hours in your tumbler – and your brass will come out looking like new!



EEMANN TECH STAR CHAMBER CLEANING PADS
FOR AR-15 - 50PCS./PACK

Reference nr.

ET-030042



EEMANN TECH STAR CHAMBER CLEANING PADS
FOR AR-15 - 10PCS./PACK

Reference nr.

ET-030041

When cleaning the chamber of your modern sporting AR15, normal patches are simply not made for this job.

The Eemann Tech Chamber Cleaning Pads for AR15 are precision cut to easily fit into your bolt chamber.

They are specially designed for easier and faster removal of loosened carbon and help to evenly distribute solvents and lubricants.

Compatible with most standard cleaning rods.

Includes 10 wool chamber pads per pack.





RAIN HARD COVERS



HOLOSUN

G19

9mm



EEMANN TECH RAIN COVER FOR LEUPOLD
DELTAPOINT PRO

Reference nr.

ET-030064

NEW



EEMANN TECH RAIN HARD COVER FOR SHIELD
RMSX MINI SIGHT XL

Reference nr.

ET-030066

NEW



EEMANN TECH RAIN HARD COVER FOR C-MORE
RTS2

Reference nr.

ET-030069

NEW



EEMANN TECH RAIN HARD COVER EXTENDED
FOR HOLOSUN 510C WITH RAISER PLATE

Reference nr.

ET-030072

NEW



EEMANN TECH RAIN HARD COVER FOR HOLOSUN
507COMP

Reference nr.

ET-030073

NEW



EEMANN TECH RAIN HARD COVER EXTENDED FOR HOLOSUN 510C

Reference nr.

ET-030075

NEW



EEMANN TECH RAIN HARD COVER FOR HOLOSUN 510C

Reference nr.

ET-030079

NEW



EEMANN TECH RAIN HARD COVER FOR C-MORE RTS3

Reference nr.

ET-030065

NEW



SHOTGUN ACCESSORIES



EEMANN TECH COMPETITION BARREL CLAMP 12GA

Reference nr.

ET-121213

NEW

The Eemann Tech Universal Barrel Clamp is engineered to provide a secure and stable connection between your shotgun barrel and tube extension. Designed for all 12-gauge shotguns, this clamp helps maintain alignment and prevents movement during shooting, enhancing both performance and safety.

Crafted from durable aluminium and finished in a sleek black color, the clamp is not only robust but also corrosion-resistant. Its universal fit makes it compatible with a wide range of 12-gauge shotgun models equipped with tube extensions.

Material: Aluminium

Color: Black

Compatibility:

12-gauge shotguns with tube extensions



EEMANN TECH COMPETITION FOLLOWER FOR
BENELLI M1/M2

Reference nr.

ET-121201

NEW



EEMANN TECH COMPETITION FOLLOWER FOR
BENELLI M3

Reference nr.

ET-121202

NEW



EEMANN TECH COMPETITION FOLLOWER FOR
BENELLI M4

Reference nr.

ET-121203

NEW



EEMANN TECH COMPETITION FOLLOWER FOR
BENELLI NOVA/SUPERNOVA

Reference nr.

ET-121204

NEW



EEMANN TECH COMPETITION FOLLOWER FOR
BERETTA 1301

Reference nr.

ET-121205

NEW

FILIPINAS ASIA S

EEMANN
ONE EVO
BEST WELPER

G

EEMANN
ONE EVO
BEST WELPER

G

EEMANN
ONE EVO
BEST WELPER

G

EEMANN
ONE EVO
BEST WELPER

G



EEMANN
TECH
www.eemann-tech.com

Quality.
Experience.
Technology.

VALIANT

100 FIREARMS
TRAINING

EM30
MOV



APPARELS & ACCESSORIES



EEMANN TECH LIFESTYLE T-SHIRT - BLACK

Reference nr.	Size	
ET-000051	XS	NEW
ET-000052	S	NEW
ET-000053	M	NEW
ET-000054	L	NEW
ET-000055	XL	NEW
ET-000056	XXL	NEW
ET-000057	3 XL	NEW

Fabric:

(95% cotton / 5% stretch acrylic)



EEMANN TECH OFFICIAL 2025 T-SHIRT

Reference nr.	Size	Type	
ET-442232	2 XS	Regular	NEW
ET-442233	XS	Regular	NEW
ET-442234	S	Regular	NEW
ET-442235	M	Regular	NEW
ET-442236	L	Regular	NEW
ET-442237	XL	Regular	NEW
ET-442238	2 XL	Regular	NEW
ET-442239	3 XL	Regular	NEW
ET-442240	4 XL	Regular	NEW
ET-442241	5 XL	Regular	NEW
ET-442242	6 XL	Regular	NEW
ET-442243	7 XL	Regular	NEW
ET-442244	8 XL	Regular	NEW
ET-442245	9 XL	Regular	NEW
ET-442246	10 XL	Regular	NEW
ET-442247	2 XS	Women	NEW
ET-442248	XS	Women	NEW
ET-442249	S	Women	NEW
ET-442250	M	Women	NEW
ET-442251	L	Women	NEW
ET-442252	XL	Women	NEW
ET-442253	2 XL	Women	NEW
ET-442254	3 XL	Women	NEW
ET-442255	4 XL	Women	NEW
ET-442256	5 XL	Women	NEW

Fabric:

LITE-X



DED EEMANN TECH PREMIUM LARGE TOWEL

Reference nr.

ET-009063

NEW

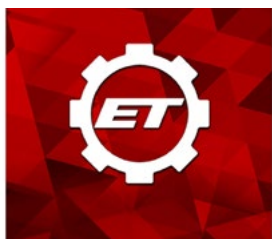

DED EEMANN TECH PREMIUM SMALL TOWEL

Reference nr.

ET-009062

NEW



EEMANN TECH PEN

Reference nr.

ET-009029



KEYCHAIN WITH EEMANN TECH LOGO

Reference nr.

ET-009053



EEMANN TECH NOTEBOOK

Reference nr.

ET-009021

Size

A5



EEMANN TECH FULL LOGO PVC PATCH

Reference nr.

ET-009051



EEMANN TECH GEAR LOGO PVC PATCH

Reference nr.

ET-009052



EEMANN TECH STEEL MUG 210ML

Reference nr.

ET-009050



EEMANN TECH TECHNICAL MOUSE PAD

Reference nr.

ET-009075

NEW



DED EEMANN TECH PREMIUM RUBBER MAT

Reference nr.

ET-009059

NEW



EEMANN TECH OFFICIAL LANYARD

Reference nr.

ET-009058

NEW



EEMANN TECH DUTY LANYARD

Reference nr.

ET-009072

NEW



EEMANN TECH CALENDAR 2026

Reference nr.

ET-009077

NEW



EEMANN TECH PLASTIC BAG - 25CM X 35CM

Reference nr.

ET-009064

NEW



EEMANN TECH CLEANING CLOTH

Reference nr.

ET-030045



EEMANN TECH LOGO 3D STICKER - WHITE

Reference nr.

ET-020037

NEW



EEMANN TECH LOGO 3D STICKER - BLACK

Reference nr.

ET-020031

NEW



EEMANN TECH GEAR LAPEL PIN 2CM

Reference nr.

ET-009019



EEMANN TECH GEAR LOGO STICKER - BLACK - 40MM

Reference nr.

ET-020030

NEW



EEMANN TECH LOGO STICKER - 400MM

Reference nr.

ET-009056



EEMANN TECH LOGO STICKER - 200MM

Reference nr.

ET-009055

FIREARM STANDS





EEMANN TECH RETAIL GRIPS DISPLAY KIT FOR CZ SHADOW 2 GRIPS

Reference nr.

ET-030071

NEW



EEMANN TECH HANDGUN DISPLAY STAND

Reference nr.

ET-030095

NEW



EEMANN TECH PCC/RIFLE DISPLAY STAND

Reference nr.

ET-030090

NEW



EEMANN TECH UNIVERSAL HANDGUN STAND

Reference nr.

ET-030091

NEW



EEMANN TECH HANDGUN DISPLAY MAGAZINE INSERT FOR GLOCK

Reference nr.

ET-030093

NEW



EEMANN TECH HANDGUN DISPLAY MAGAZINE INSERT FOR 2011

Reference nr.

ET-030096

NEW



EEMANN TECH HANDGUN DISPLAY MAGAZINE INSERT FOR 1911

Reference nr.

ET-030097

NEW



EEMANN TECH HANDGUN DISPLAY MAGAZINE INSERT FOR CZ COMPACT

Reference nr.

ET-030098

NEW



EEMANN TECH HANDGUN DISPLAY MAGAZINE INSERT FOR SIG P320

Reference nr.

ET-030089

NEW



EEMANN TECH HANDGUN DISPLAY MAGAZINE
INSERT FOR CANIK

Reference nr.

ET-030077

NEW



EEMANN TECH HANDGUN DISPLAY MAGAZINE
INSERT FOR WALTHER PDP

Reference nr.

ET-030078

NEW



EEMANN TECH DISPLAY MAGAZINE INSERT FOR
PCC GLOCK MAGS

Reference nr.

ET-030082

NEW



EEMANN TECH DISPLAY MAGAZINE INSERT FOR
GP PCC STRIBOG

Reference nr.

ET-030083

NEW



EEMANN TECH DISPLAY MAGAZINE INSERT FOR
CZ SCORPION EVO

Reference nr.

ET-030084

NEW



IWA
OUTDOOR
CLASSICS

Stay in contact with us:

Härgmäe 24, Tallinn
13525 Estonia

export@eemann.tech
www.eemann.tech



facebook.com/eemanntechofficial
instagram.com/eemanntech
youtube.com/eemanntech

